

BILL NO. 179  
(DRAFT 3)

ORDINANCE NO. \_\_\_\_\_

**AN ORDINANCE ESTABLISHING A COUNTY CONSTRUCTION CODE RELATING TO BUILDING CONSTRUCTION AND RELATED SYSTEMS WITHIN A BUILDING UNDER CONSTRUCTION BY AMENDING THE HAWAI'I COUNTY CODE 1983 (2016 EDITION, AS AMENDED), AS FOLLOWS:**

- 1) **ADOPTING NEW CHAPTERS 5 (CONSTRUCTION ADMINISTRATIVE CODE), 5A (BUILDING CODE), 5D (ELECTRICAL CODE), 5E (ENERGY CONSERVATION CODE), AND 5F (PLUMBING CODE);**
- 2) **AMENDING CHAPTER 2, SECTION 2-39; CHAPTER 3, SECTIONS 3-14 AND 3-15; AND CHAPTER 25, SECTIONS 25-1-5, 25-4-10, AND 25-4-60; AND**
- 3) **REPEALING CHAPTERS 5 (BUILDING CODE), 9 (ELECTRICAL CODE), AND 17 (PLUMBING CODE).**

**BE IT ORDAINED BY THE COUNCIL OF THE COUNTY OF HAWAI'I:**

**SECTION 1. Background.**

The administrative provisions for the building, electrical, and plumbing codes are presently contained in chapters 5, 9, and 17. This ordinance extracts them from these chapters and consolidates them into a single new chapter. This consolidation will enable the department of public works to streamline its administration of the permit application and plan review process by consolidating what are presently separate permits from each of these chapters into a single permit. The fees for this permit are derived from a simplified fee structure that is based upon the value of the work to be performed. These changes will standardize procedures for standard administrative activities such as permitting and inspections, facilitate implementation of the County's EnerGov online permitting system, reduce permit processing time, and generally facilitate the department of public works' efforts to regulate building and construction in the County more efficiently and effectively.

The installation provisions for these codes are placed in new chapters dedicated to the following areas: building; electrical; energy conservation, and plumbing. This structure will ease the regular updates to these codes that are required in response to changes to the Hawaii State building codes, pursuant to section 107-28, Hawai'i Revised Statutes.

Collectively, these chapters will comprise the County's construction code. The purpose of this code is to: protect public health and safety, safeguard property, and promote the public welfare by establishing minimum standards for:

- (1) Building work, namely the construction, enlargement, alteration, repair, relocation, improvement, removal, conversion, or demolition of any building or structure;
- (2) Electrical work, namely the installation, alteration, reconstruction, or repair of electrical wiring;
- (3) Plumbing work; namely the installation, alteration, reconstruction, or repair of plumbing, gas, and drainage systems; and
- (4) The energy efficient design of building envelopes and installation of mechanical, lighting, and power systems.

The table below outlines the contents of the five chapters that will comprise the County's construction code. The first column lists the proposed sections in this new construction code in consecutive numerical order. The second column shows section numbers from relevant sections in the existing County Code. These new sections were drafted after consideration of model codes, the State building codes, and codes from other Counties in the State. Consequently, in many instances the language in the new sections is not identical to that in existing sections. The third column includes the names of the new sections.

**Table of Sections**

<b>Proposed Section</b>	<b>Existing Section</b>	<b>Section Name</b>
<b>Chapter 5. Construction Administrative Code</b>		
Article 1. General Provisions		
5-1-1	5-1, 9-1, 17-1.	Title
5-1-2	5-1, 9-2, 17-1	Purpose
5-1-3	5-2, 9-3, 17-2	Scope, exceptions
5-1-4		Existing buildings
5-1-5	5-4, 5-71(1), 5-79, 9-5, 17-3	Definitions
5-1-6		Licenses
5-1-7		Computation of time
5-1-8		Additional time after service by mail

Article 2. Administration		
<i>Division 1. General</i>		
5-2-1	5-10, 9-6, 17-7	Department having jurisdiction
5-2-2	5-11, 9-6, 9-9(a), 17-8	Duties of the authority having jurisdiction
5-2-3	5-12, 9-15, 17-9	Compliance required
5-2-4	5-5, 9-4, 17-4	Conflict
5-2-5	5-13, 9-20, 17-10	Adoption of rules
5-2-6	5-14, 9-8, 17-11	Right of entry
5-2-7	5-15	Deputies
5-2-8	5-16, 9-7, 17-1, 17-13	Limited liability of authorized personnel
<i>Division 2. Materials, equipment, devices, design, and methods of construction</i>		
5-2-21	5-3(b)(1)	Approved materials, equipment, and devices.
5-2-22	5-3(b)(3)	Used materials, equipment, and devices
5-2-23	5-3(b)(3)	Alternative materials, equipment, design, or methods of construction
5-2-24	5-3(b)(2)	Modifications
Article 3. Permits; When Required		
<i>Division 1. Permits required</i>		
5-3-1	5-19, 9-26, 17-15	Permit required; generally
5-3-2	9-3(5)	Relocation of buildings
5-3-3		Temporary permits; required
5-3-4	5-19(a), 9-29, 17-15(b)	Separate permit; required
<i>Division 2. Permits not required</i>		
5-3-21	5-19.1(b)	Permit exemptions
5-3-22	5-19.1	Building work; exempt
5-3-23	9-26	Electrical work; exempt
5-3-24	17-16	Plumbing work; exempt
5-3-25	9-26(6), 9-28, 17-28(b)	Emergency work

Article 4. Permit Application		
<i>Division 1. Application</i>		
5-4-1	5-20, 9-30, 17-18	Application for permit
5-4-2	5-25, 5-27, 9-30(b), 17-18(a)	Plans, specifications, and other data
5-4-3	5-25, 9-33, 17-18(b)	Engineers and architects; work
5-4-4		Contractors and specialty contractors; work
5-4-5	5-28(a), 9-32, 9-34, 17-18(c)	Review of application
5-4-6	5-28(a), 9-34, 17-18(c).	Action on application
5-4-7		Cancellation of application
5-4-8		Applications made prior to subsequent changes in applicable laws
<i>Division 2. Pre-approval</i>		
5-4-21	5-26	Model plans for residential dwellings; pre-approval
Article 5. Permits		
5-5-1	5-28(b)(c), 9-34, 9-36, 17-18(c)	Issuance
5-5-2	5-21, 5-28(d), 9-36, 17-15(d)	Posting
5-5-3	5-28(e)(f), 9-37, 17-17	Designation of person, contractor, or subcontractor who will do work
5-5-4	5-22, 9-36, 17-18(e)	Expiration
5-5-5	5-22(a)	Extension
5-5-6		Retention of plans
Article 6. Eligibility to Work		
5-6-1	9-35 and 17-17	Persons to whom a permit may be issued
5-6-2	5-4, 5-33, 9-16, 17-15(c), 17-21(a)	Eligibility to perform work

Article 7. Fees		
5-7-1		Permit plan review; general
5-7-2		Plan review fee for pre-approved model plans for residential dwellings
5-7-3	5-31, 5-34, 5-35, 9-40, 9-41, 9-42, 17-28	Permit
5-7-4		Temporary permit
5-7-5	5-36(a)(b)(c), 9-43, 17-29(a)(b)(c)	Extra or regulatory inspections
5-7-6	5-45(c)	Temporary certificate of occupancy
5-7-7	9-39	Fee payment
5-7-8	5-32, 9-39.1, 17-18(g)	Refunds
Article 8. Inspections		
<i>Division 1. General provisions</i>		
5-8-1	5-40, 5-41, 9-9(d), 17-24, 17-25(c).	General requirements
5-8-2	5-40(b), 5-41, 9-11, 17-25	Work shall be visible for inspection
5-8-4	5-41, 5-42, 9-9, 9-11, 17-24, 17-25	Inspections
5-8-5	5-43, 9-12, 17-15(d)	Final inspection
5-8-6	5-44	Special inspection
5-8-7	5-36(a), 9-43, 17-29	Regulatory inspection
<i>Division 2. Authorization for service; certificate of occupancy</i>		
5-8-21	9-13	Permanent electrical service
5-8-22	5-45	Certificate of occupancy
Article 9. Unsafe Buildings or Structures		
5-9-1	5-48 and 5-49	Unsafe buildings or structures; public nuisances
5-9-2	5-48(1)	Substandard
5-9-3	5-48(2)	Structurally unsafe
5-9-4	5-48(3)(4)(5)(6)(7), 9-10, 17-37	Dangerous or hazardous
5-9-5	5-50	Inspection
5-9-6	5-50, 5-51(a)(b), 9-10, 17-37(b)(c)(d)	Found to be unsafe; notice and order

5-9-7	5-51(a) & (c), 5-52	Posting of signs
5-9-8	5-53	Action upon noncompliance
Article 10. Violations, Penalties, and Enforcement		
5-10-1	5-58(b), 5-59(a), 9-16.1, 17-32	Violations
5-10-2	5-60, 9-16.2, 17-33	Administrative enforcement
5-10-3	5-61, 9-16.4, 17-35	Criminal prosecution
5-10-4	5-62, 9-16.5, 17-36	Injunctive action
5-10-5	17-38	Remedies cumulative
Article 11. Variances and Appeals		
5-11-1	5-65, 9-17, 17-41	Variances
5-11-2	5-66, 9-18, 17-42	Appeals regarding alternative materials, design, and methods of construction
5-11-3	5-67, 9-19, 17-43	Other appeals
5-11-4	5-68, 9-20, 17-44	Rules; Adoption by the board of appeals
<b>Chapter 5A. Building Code</b>		
Article 1. General Provisions		
5A-1-1	5-1	Title
5A-1-2	5-1(b)	Purpose
5A-1-3	5-2, 5-3, 9-3(2)(3)	Scope; exceptions
5A-1-4		Administrative provisions
5A-1-5	5-6	Existing buildings
5A-1-6	5-4, 5-19(a), 9-5,	Definitions
5A-1-7	5-12, 9-15(b)	Compliance required
5A-1-8	5-5, 5-12(8)	Conflict
5A-1-9	5-12	References to model codes
Article 2. Installation Requirements		
5A-2-1	5-3(a)	International building code adopted

Article 3. Adoption, Amendment, and Addition of Appendices		
<i>Division 1. Appendices of International Building Code Adopted</i>		
5A-3-1	5-74	Appendices not applicable
5A-3-2	5-75	Appendices adopted
5A-3-3	5-76	Amendments to Appendix C; Group U – Agricultural Buildings
<i>Division 2. Appendices Added to the International Building Code.</i>		
5A-3-21	5-78	Appendices added to International Building Code
5A-3-22	5-79	Appendix L; Factory-built Housing.
5A-3-23	5-80	Appendix M; Thatch Material on Exterior of Buildings - Protection Against Exposure Fires
5A-3-24	5-81	Appendix U; Hawai'i Hurricane Sheltering Provisions for New Construction
5A-3-25	5-82	Appendix W; Hawai'i Wind Design Provisions for New Construction
5A-3-26	5-83	Appendix X; Indigenous Hawaiian Architecture Structures
5A-3-27		Appendix Y; Tiny Houses
Article 4. Building Work Within Special Flood Hazard Areas		
5A-4-1	17-50	General applicability
5A-4-2	9-5, 27-12	Definitions
5A-4-3		General Requirements
<b>Chapter 5D. Electrical Code</b>		
Article 1. General Provisions		
5D-1-1	9-1	Title
5D-1-2	9-2	Purpose
5D-1-3	9-3(1)(2)(3)(6)(7)(8)	Scope; exceptions
5D-1-4		Administrative provisions

5D-1-5	9-3(4)	Existing electrical installations
5D-1-6	9-5	Definitions
5D-1-7	9-15(a)(b), 9-27(b)	Compliance required
5D-1-8	9-4	Conflict
<b>Article 2. Installation Requirements</b>		
5D-2-1	9-14	National electrical code adopted
<b>Article 3. Electrical Work Within Special Flood Hazard Areas</b>		
5D-3-1	9-24	General applicability
5D-3-2	9-5, 27-12	Definitions
5D-3-3		General Requirements
5D-3-4	9-24(1)	Services
5D-3-5	9-24(2)	Ground fault protection
5D-3-6	9-24(3)	Wiring method and material.
<b>Chapter 5E. Energy Conservation Code</b>		
<b>Article 1. General Provisions</b>		
5E-1-1	5-85(b)(1)	Title
5E-1-2	5-84	Purpose
5E-1-3	5-85(b)(2)	Scope; exceptions
5E-1-4		Administrative provisions
5E-1-5		Existing construction and installations
5E-1-6	5-85(b)(6), (27)	Definitions
5E-1-7	5-85(b)(22), (28), (43)	Compliance required
5E-1-8		Conflict
<b>Article 2. Installation Requirements</b>		
5E-2-1	5-85(a)	International Energy Conservation Code adopted

<b>Chapter 5F. Plumbing Code</b>		
<b>Article 1. General Provisions</b>		
5F-1-1	17-1(a)	Title
5F-1-2	17-1(b)	Purpose
5F-1-3	17-2	Scope; exceptions
5F-1-4		Administrative provisions
5F-1-5		Existing plumbing installations
5F-1-6	17-3	Definitions
5F-1-7	17-9, 17-18(d), 17-21(a),	Compliance required
5F-1-8	17-4	Conflict
<b>Article 2. Installation Requirements</b>		
5F-2-1	17-47	Uniform plumbing code adopted
<b>Article 3. Plumbing Work Within Special Flood Hazard Areas</b>		
5F-3-1	17-50	General applicability
5F-3-2	17-52	Definitions
5F-3-3	17-53	Drainage (plumbing) systems
5F-3-4	17-54	Private sewage disposal/treatment
5F-3-5	17-55	Water supply systems
5F-3-6	17-56	Plumbing piping under buildings

## PART I. NEW CHAPTERS

**SECTION 2.** The Hawai‘i County Code 1983 (2016 Edition, as amended) is amended by adding a new chapter 5 that shall read as follows:

### **“CHAPTER 5. CONSTRUCTION ADMINISTRATIVE CODE.**

#### **Article 1. General Provisions.**

##### **Section 5-1-1. Title.**

This chapter shall be known as the “construction administrative code.”

##### **Section 5-1-2. Purpose.**

This chapter consolidates the administrative provisions relating to the County’s construction code, including chapters 5A, the building code; 5D, the electrical code; 5E, the energy conservation code; and 5F, the plumbing code into one chapter. These administrative provisions relate to: permitting; enforcement; inspections; and related procedures. This consolidation will enable the County to develop a system based on a single permit, rather than multiple construction permits and generally promote consistency in procedures across construction disciplines. The purpose of these policy changes is to enable the County to implement its responsibilities in this area with greater efficiency and effectiveness.

##### **Section 5-1-3. Scope; exceptions.**

The provisions of this chapter shall apply to the administrative, permitting, enforcement, inspection, and related procedures of chapters: 5A, the building code; 5D, the electrical code; 5E, the energy conservation code; and 5F, the plumbing code.

This chapter shall apply to all building, electrical, and plumbing work related to the construction, alteration, movement, addition, replacement, repair, establishment of and changes in use and occupancy, location, maintenance, removal and demolition of every building or structure or any appurtenances connected or attached to such buildings or structures within the County inland of the shoreline high-water line.

This chapter shall not apply to:

- (1) Work on buildings or premises owned by or under the direct control of the Federal government;
- (2) Work in public State or County road right-of-ways for utility installations, street lighting, traffic signals, police and fire alarms, bridges, poles, hydraulic flood control structures, and mechanical equipment not specifically regulated in this code where installed:

- (A) Outside the proposed premises or boundary lines in a subdivision under development; or
  - (B) In an approved subdivision, where the work is in planned or actual roadways or other common infrastructure areas;
- (3) Pursuant to section 448E-13, Hawai'i Revised Statutes, work by employees of a public utility within the State under a franchise or charter granted by the State which is regulated by the public utilities commission and community antennae television company, while so employed;
  - (4) Electrical work related to work regulated by chapter 397, Hawai'i Revised Statutes, relating to the elevator code, but not including electrical work for the supply of power to the control panels of elevators, dumbwaiters, escalators, moving walks, and manlifts;
  - (5) Replacement or repair of electrical devices and apparatus for air conditioning, refrigeration, and heating systems, except electrical work on overcurrent devices that are not physically attached to, or physically mounted on, such systems;
  - (6) The construction, alteration or repair of electrical devices commonly used in the home such as portable appliances as defined in section 5-1-5;
  - (7) Plumbing work related to work regulated by chapter 397, Hawai'i Revised Statutes, relating to boilers and pressure vessels; and
  - (8) Agricultural buildings, structures, and appurtenances without electrical power and plumbing systems are exempt from permit and construction code requirements pursuant to section 46-88, Hawai'i Revised Statutes, except as otherwise provided for in this construction code. No electrical power and no plumbing systems shall be connected to a building or structure without first obtaining a permit for electrical or plumbing work.

**Section 5-1-4. Existing buildings.**

- (a) Permitted buildings in existence at the time of the adoption of this code may have their existing permitted use or occupancy continued if such use or occupancy was legal at the time of the adoption of this code, provided such continued use does not constitute a hazard to the general safety and welfare of the occupants and the public.
- (b) Alteration, repair, addition, and change of occupancy. Alteration, repair, addition, and change of occupancy to a building or structure in existence at the time of the adoption of this code shall comply with the requirements of chapter 34 of the International

Building Code, relating to existing structures, until the adoption by the County of the International Existing Building Code.

**Section 5-1-5. Definitions.**

As used in this chapter, unless it is apparent from the context that a different meaning is intended:

“**Accessory structure**” means a structure not greater than 3,000 square feet (279 m<sup>2</sup>) in floor area, and not over two stories in height, the use of which is customarily accessory to and incidental to that of the dwelling and which is located on the same lot.

“**Agricultural building**” means a development, including a nonresidential building or structure, built for agricultural or aquacultural purposes, located on a commercial farm or ranch constructed or installed to house farm or ranch implements, agricultural or aquacultural feeds or supplies, livestock, poultry, or other agricultural or aquacultural products, used in or necessary for the operation of the farm or ranch, or for the processing and selling of farm or ranch products. An agricultural building for personal use shall be excluded from this definition.

“**Architect**” means a person who is licensed and in good standing as an architect in the State of Hawai‘i.

“**Authority having jurisdiction**” means the director of the department of public works, or the director’s authorized representative.

“**Building**” means any structure used or intended for supporting or sheltering any use or occupancy. The term shall include but not be limited to, any structure mounted on wheels such as a trailer, wagon, or vehicle which is parked and stationary for any 24-hour period, and is used for business or living purposes; provided, however, that the term shall not include a push cart or push wagon which is readily movable and which does not exceed 25 square feet in area, nor shall the term include a trailer or vehicle, used exclusively for the purpose of selling any commercial product therefrom, which hold a vehicle license and actually travels on public or private streets.

To the extent context otherwise permits and/or requires, the definitions of “building” as used in chapters: 5A, the building code; 5D, the electrical code; 5E, the energy conservation code; and 5F, the plumbing code; are incorporated by reference herein.

“**Building work**” means the design, construction, alteration, relocation, enlargement, replacement, repair, removal, demolition of any building or structure, or any other activities regulated by this chapter.

**“Construction code”** means collectively: chapter 5, the construction administrative code; chapter 5A, the building code; chapter 5D, the electrical code; chapter 5E, the energy conservation code; chapter 5F, the plumbing code; and all administrative rules adopted pursuant to these chapters.

**“Director”** means the director of public works of the County of Hawai‘i or the director’s duly authorized representative.

**“Dwelling”** means any building that contains one or two dwelling units used, intended, or designed to be built, used, rented, leased, let or hired out to be occupied, or that are occupied for living purposes.

**“Dwelling unit”** means a single unit providing complete independent living facilities for one or more persons, including permanent provisions for living, sleeping, eating, cooking, and sanitation.

**“Electrical wiring”** means any conduit, raceway, manhole, handhole, conductor, material, device, fitting, apparatus, appliance, fixture, or equipment constituting a part of or connected to any electrical installation, attached or fastened to any building, structure, or premises and which installation or portion thereof is designed, intended, or used to generate, transmit, transform, or utilize electrical energy within the scope and purpose of the National Electrical Code.

**“Electrical work”** means the installation, alteration, reconstruction, or repair of electrical wiring.

**“Engineer”** means a person who is licensed and in good standing as a professional engineer in the State of Hawai‘i.

**“Existing building”** means a building erected prior to the effective date of this chapter, or one for which a legal permit has been issued.

**“Existing structure”** means a structure erected prior to the effective date of this chapter, or one for which a legal permit has been issued.

**“Factory-built home”** means a dwelling or dwelling unit, any structure or portion thereof, which is either entirely prefabricated or assembled at a place other than the building site.

**“International building code”** means the International Building Code published by the International Code Council, Inc., 4051 West Flossmoor Road, Country Club Hills, IL, 60478-5795, including appendices, as adopted in chapter 5A.

**“Owner”** means any individual, firm, partnership, association, or corporation, its or their successors or assigns, according to the context thereof as owners or lessees of property.

**“Owner-builder”** means owners or lessees of property who build or improve buildings or structures on their property for their own use, or for use by their immediate family. This definition shall not preempt owner-builder by exemption as defined by section 444-2.5, Hawai‘i Revised Statutes.

**“Permit”** means a formal authorization issued by the authority having jurisdiction that authorizes performance of specified work, pursuant to the construction code, including the following chapters and all administrative rules adopted pursuant to these chapters:

- (1) 5, the construction administrative code;
- (2) 5A, the building code;
- (3) 5D, the electrical code;
- (4) 5E, the energy conservation code; and
- (5) 5F, the plumbing code.

**“Person”** means any individual, firm, partnership, association, or corporation; or its or their successors or assigns, according to the context thereof.

**“Plumbing work”** means the design, installation, alteration, construction, reconstruction, or repair of plumbing, gas, and drainage systems.

**“Portable appliances”** means any cord/plug connected device that is readily movable.

**“Regulatory inspection”** means an inspection that is requested to satisfy the requirements of laws that are other than the construction code and that relate to health, safety, or public welfare.

**“Responsible party”** means, at a minimum, the owner of a building, structure, portion thereof, or installation. “Responsible parties” may also include, but shall not be limited to any lessee or tenant of the building, structure, or portion thereof, and the owner of the property where the building, structure, or portion thereof, or installation is located.

**“Special inspection”** means an inspection of the materials, installation, fabrication, erection or placement of components and connections requiring special expertise to ensure compliance with approved construction documents and referenced standards.

**“Structure”** means that which is built or constructed.

**Section 5-1-6. Licenses.**

When this construction administrative code or any of the construction codes require that a person be licensed pursuant to chapters 444, 448E, or 464, of the Hawai'i Revised Statutes, such license must be valid in the State of Hawai'i, unexpired, and unrevoked.

**Section 5-1-7. Computation of time.**

In computing any period of time prescribed or allowed by the construction administrative code, or by any applicable law or rule, the day of the act, event, or default after which the designated period of time begins to run shall not be included. The last day of the period so computed shall be included unless it is a Saturday, Sunday, or holiday, in which event the period runs until the end of the next day that is not a Saturday, Sunday, or holiday. When the period of time prescribed or allowed is less than seven consecutive days, intermediate Saturdays, Sundays, and holidays shall be excluded in the computation. As used in the construction administrative code, "holiday" includes any day designated as such pursuant to section 8-1, Hawai'i Revised Statutes.

**Section 5-1-8. Additional time after service by mail.**

Whenever a party has the right or is required to do some act or take some proceedings within a prescribed period after the service of a notice or other paper upon the party, if the notice or paper is served upon the party by mail, two days shall be added to the prescribed period. This period shall begin as of the date of mailing.

**Article 2. Administration.**

**Division 1. General.**

**Section 5-2-1. Department having jurisdiction.**

Unless otherwise provided for by law, the director of public works, in the director's capacity as the authority having jurisdiction, shall have jurisdiction over and administer all matters covered by the construction code.

**Section 5-2-2. Duties of the authority having jurisdiction.**

The authority having jurisdiction shall administer the provisions of the construction code and amendments thereto and shall perform the following duties:

- (1) Administer and enforce the provisions of the construction code, including chapters: 5, the construction administrative code; 5A, the building code; 5D, the electrical code; 5E, the energy conservation code; and 5F, the plumbing code; in a manner consistent with the intent thereof;
- (2) Render interpretations of the construction code and adopt policies and procedures that are consistent with the intent and purpose of this code. Such policies and

procedures shall not have the effect of waiving requirements specifically provided for in the construction code;

- (3) Require submission of, examine, and check plans and specifications, drawings, descriptions and diagrams necessary to show clearly the character, kind, and extent of work covered by applications for a permit, and upon approval, shall issue the permit applied for;
- (4) Inspect all building, electrical, and plumbing work authorized by permit to assure compliance with provisions of the construction code or amendments thereto, approving or condemning said work in whole or in part as conditions require;
- (5) Condemn and reject all work done or being done or materials used or being used which do not in all respects comply with the provisions of the construction code and amendments thereto;
- (6) Order changes in workmanship and materials essential to obtain compliance with all provisions of the construction code;
- (7) Issue upon request a certificate of occupancy or certificate of completion for any work approved by the authority having jurisdiction;
- (8) Investigate any construction or work regulated by the construction code and issue such notices and orders as provided in the construction code;
- (9) Keep a complete record of all essential transactions; and
- (10) Maintain public office hours necessary to administer the provisions of the construction code and amendments thereto.

**Section 5-2-3. Compliance required.**

- (a) Permit holders and their agents shall comply with the requirements of permits issued pursuant to the construction code including chapters: 5, the construction administrative code; 5A, the building code; 5D, the electrical code; 5E, the energy conservation code; and 5F, the plumbing code.
- (b) Any approval or permit issued pursuant to the provisions of the construction code shall comply with all applicable requirements of the construction code. Any approval or permit that presumes to authorize violation of the provisions of the construction code, or other applicable laws, shall be invalid, except insofar as the work or use it authorizes is lawful.
- (c) The granting of a permit, variance, or approval of plans or specifications pursuant to the construction code does not dispense with the necessity to comply with any applicable law to which a permit holder may also be subject.

**Section 5-2-4. Conflict.**

- (a) If any provisions of the construction code conflict with or contravene provisions of the Hawai'i State Building Codes, International Building Code, National Electrical Code, Uniform Plumbing Code, or the International Energy Conservation Code, that have

been incorporated by reference, the provisions of the construction code shall prevail as to all matters and questions arising out of the subject matter of that provision.

- (b) In situations where two or more provisions of the construction code and any applicable law, other than those provided for in subsection (a), cover the same subject matter, the stricter shall be complied with.

**Section 5-2-5. Adoption of rules.**

The authority having jurisdiction may adopt rules pursuant to chapter 91, Hawai'i Revised Statutes, necessary for the purposes of the construction code.

**Section 5-2-6. Right of entry.**

Upon presentation of proper credentials, the authority having jurisdiction may enter a building, structure, premises, or building site at reasonable times to inspect or to perform any duty imposed by the construction code. Such entry shall be made in such a manner as to cause the least possible inconvenience to the persons in possession. If such building, structure, premises, or building site is unoccupied, the authority having jurisdiction shall first make a reasonable effort to locate the owner, owner's agent, or person responsible for the building, structure, premises, or building site and request entry. An order of a court authorizing such entry shall be obtained in the event such entry is denied or resisted.

**Section 5-2-7. Deputies.**

In accordance with applicable procedures the authority having jurisdiction shall have the authority to:

- (1) Appoint technical officers, inspectors, plan examiners, and other personnel necessary to support the department;
- (2) Deputize inspectors or employees who shall have powers delegated to them by the authority having jurisdiction; and
- (3) Deputize volunteers to temporarily carry out functions of the department in the event of an emergency as defined in chapter 127A, Hawai'i Revised Statutes.

**Section 5-2-8. Limited liability of authorized personnel.**

- (a) The authorized personnel charged with the administration and enforcement of the construction code, while acting in good faith and without malice in the discharge of the duties required by the construction code or other applicable law, shall not thereby be rendered personally liable for damages that may accrue to persons or property as a result of an act or by reason of an act or omission in the discharge of such duties. A suit brought against the authorized personnel because of such act or omission performed by the authorized personnel in the enforcement of any provision of the construction code or other applicable law implemented through the enforcement of the construction code shall be defended by the County until final termination of such proceedings, and any judgment resulting therefrom shall be assumed by the County.

- (b) Neither the County nor any department, board, commission, officer, employee, or agent shall be held liable or responsible for any damage or injury caused by or resulting from the issuance of any permit, or any inspection or approval or issuance of a certificate of inspection, made under the provisions of the construction code.
- (c) The construction code shall not be construed to relieve from or lessen the responsibility of any person for damages from any defect, arising out of the ownership, operation, or installation of any:
  - (1) Electrical wires, appliances, apparatus, construction, or equipment; or
  - (2) Plumbing, gas, or drainage systems.

**Division 2. Materials, equipment, devices, design, and methods of construction.**

**Section 5-2-21. Approved materials, equipment, and devices.**

Materials, equipment, and devices approved by the authority having jurisdiction shall be constructed and installed in accordance with such approval.

**Section 5-2-22. Used materials, equipment, and devices.**

The use of used materials that meet the requirements of the construction code for new materials is permitted. Used equipment and devices shall not be reused unless approved by the authority having jurisdiction.

**Section 5-2-23. Alternative materials, equipment, design, or methods of construction.**

- (a) The provisions of the construction code are not intended to prevent the installation of any material or equipment; or to prohibit any design or method of construction not specifically prescribed by this code, provided that any such alternative has been approved by the authority having jurisdiction.
- (b) Requests for qualified and approved alternative materials, equipment, design, or methods of construction shall include a stamped certification from a person who is licensed in the State of Hawai'i as an architect or professional engineer, that the proposed alternative meets or exceeds the standards set in subsection (c). Supporting data as prescribed in subsections (d) and (e) shall be required to support the request.
- (c) An alternative material, equipment, design, or method of construction may be approved where the authority having jurisdiction finds that the proposed design is satisfactory and complies with the intent of the provisions of the construction code, and that the material, equipment, method, or work offered is, for the purpose intended, at least the equivalent of that prescribed in this code in quality, strength, effectiveness, fire resistance, durability, and safety.

- (d) Research reports. Supporting data, where necessary to assist in the approval of materials, assemblies, or equipment not specifically provided for in the construction code, shall consist of valid research reports from approved sources.
- (e) Tests. Whenever there is insufficient evidence of compliance with the provisions of the construction code, or evidence that a material or method does not conform to the requirements of this code, or in order to substantiate claims for alternative materials or methods, the authority having jurisdiction shall have the authority to require tests as evidence of compliance to be made at no expense to the County. Test methods shall be as specified in the construction code or by other recognized test standards. In the absence of recognized and accepted test methods, the authority having jurisdiction shall approve the testing procedures. Tests shall be performed by an approved agency. Reports of such tests shall be retained by the authority having jurisdiction for the period required for retention of public records.

**Section 5-2-24. Modifications.**

- (a) Wherever there are practical difficulties involved in carrying out the provisions of the construction code, the authority having jurisdiction may grant modifications for individual cases, upon application by an owner or owner's representative. As used in this section, "modification" means an exception to the provisions of the construction code that may be granted in individual cases, by the authority having jurisdiction.

No modification from the strict application of any provision of the construction code shall be granted by the authority having jurisdiction unless it finds all of the following:

- (1) That an individual reason exists that in this instance renders compliance with the strict letter of the construction code impractical;
  - (2) The modification will be consistent with the intent and purpose of the construction code; and
  - (3) That the granting of the modification will not lessen health, accessibility, life and fire safety, or structural requirements.
- (b) In granting a modification, the authority having jurisdiction may prescribe conditions that it deems to be necessary or desirable.
  - (c) The details of actions granting modifications shall be recorded and entered in the files of the authority having jurisdiction.

### **Article 3. Permits; When Required.**

#### **Division 1. Permits required.**

##### **Section 5-3-1. Permit required; generally.**

- (a) Except as provided in division 2, no person shall perform any of the following work or cause or permit the same to be done on any building or structure in the County, without first obtaining a permit for this work from the authority having jurisdiction:
  - (1) Erect, construct, enlarge, alter, repair, relocate, improve, remove, convert, or demolish any building or structure;
  - (2) Erect, install, enlarge, alter, repair, remove, convert, or replace any electrical work; or
  - (3) Erect, install, enlarge, alter, repair, remove, convert, or replace any plumbing, fire sprinkler, gas, or drainage piping work, or any fixture, gas appliance, water heating, or water treating equipment.
  
- (b) A permit shall be required for, but not limited to, the following:
  - (1) Gas tanks and piping.  
Installation, removal, alteration, repair, or replacement of all gas tanks and piping on private property.
  - (2) Handicap accessible routes.  
Construction or renovation of handicap accessible routes from parking lot to building or from building to building on a lot.
  - (3) Retaining walls.  
Erection, construction, enlargement, alteration, repair, moving, conversion, or demolition of retaining walls four feet and higher. Stepped or terraced retaining walls within eight feet of each other are considered to be one wall when determining wall height.
  - (4) Solar photovoltaic systems.  
Complete new installations of all solar photovoltaic residential and non-residential systems, or the replacement of an existing system with all new components, or relocation of panels from roof to ground or vice versa.
  - (5) Solar water heating systems or components.  
Complete new installations of all solar water heating systems, the complete replacement of existing system with all new components, or relocation of panels from roof to ground or vice versa.
  - (6) Television or radio communication towers.  
Erect, construct, enlarge, alter, repair, relocate, convert, or demolish any television or radio communication tower that is not regulated by the public utilities commission.

- (7) Water tanks or catchments. Installation, removal, alteration, repair, or replacement of water tanks or catchments intended for potable use, household use, or fire protection, regardless of height or size. For additional requirements where water tank or catchment systems are used as means of fire protection, see chapter 26, Hawai'i County Code.
- (8) Air conditioning systems. Installation, removal, alteration, repair, or conversion of any heating, ventilation, or air conditioning system.

**Section 5-3-2. Factory-built housing.**

- (a) No person shall perform any of the following work or cause or permit the same to be done on any factory-built housing in the County, without first obtaining a permit for this work from the authority having jurisdiction:
  - (1) Manufacture, install, erect, construct, enlarge, alter, repair, relocate, improve, remove, convert, or demolish any factory-built housing;
  - (2) Manufacture, erect, install, enlarge, alter, repair, remove, convert, or replace any electrical work; or
  - (3) Manufacture, erect, install, enlarge, alter, repair, remove, convert, or replace any plumbing, fire sprinkler, gas, or drainage piping work, or any fixture, gas appliance, water heating, or water treating equipment.
- (b) To obtain a permit, an applicant shall comply with sections: 5-4-1; 5-4-2, 5-4-3, 5-4-4, 5-4-5, 5-4-6, 5-4-7, and 5-4-8.
- (c) For the purposes of this section, "manufacture" means the process of making, fabricating, constructing, forming, or assembling a FBH at a place other than the building site.

**Section 5-3-3. Relocation of buildings.**

- (a) A permit is required to relocate a building pursuant to section 5-3-1.
- (b) Buildings moved into or within the jurisdiction shall comply with the provisions of the construction code for new structures.  
Exception:  
R3 dwellings are exempted from this subsection but existing plumbing and electrical systems contained within R3 dwellings shall be brought up to current code.
- (c) No permit shall be issued to relocate any dwelling, accessory to a dwelling, or portion thereof, that has sustained substantial damage. As used in this section, "substantial damage" means damage of any origin sustained by a structure, whereby the cost of

restoring the structure to its undamaged condition would equal or exceed fifty percent of the market value of the structure before damage occurred.

- (d) Except as otherwise provided in subsection (b), the foundation, plumbing, and electrical work at the final destination of the relocated building shall comply with the provisions of the construction code for new structures and shall comply with flood hazard regulations, land use ordinances and all other applicable laws.

**Section 5-3-4. Temporary permits; required.**

- (a) The authority having jurisdiction may authorize a permit for temporary structures and temporary uses. A temporary permit for tents and similar structures shall be limited to a period of not more than one hundred eighty consecutive days unless regulated by the fire code. The authority having jurisdiction may grant one or more extensions of time for additional periods not exceeding ninety consecutive days each. Prior to the deadline, requests for extension shall be filed in writing with the authority having jurisdiction, and demonstrate that circumstances beyond the applicant's control justify granting the extension request. A \$50 fee is required for a temporary permit.
- (b) A temporary permit shall be required for, but not limited to, installation or construction of the following structures for a period of not more than one hundred eighty consecutive days:
  - (1) A tent or similar structure which is to be used for commercial or religious purposes, such as rallies, festivals, amusements and sideshows;
  - (2) Props for films, television, or live plays and performances; or
  - (3) Structures, buildings, platforms, construction trailers, water tanks, or fences used during the construction of a permitted structure.
- (c) Tents of canvas, plastic or similar material shall not be used as a residence.
- (d) The grant of a temporary permit pursuant to this section shall not be deemed to grant authorization for any electrical or plumbing work to be done in a manner that violates the provisions of the construction code or any other applicable laws.
- (e) The permit may be canceled for cause by the authority having jurisdiction or the fire department at any time before expiration of the time stated in the permit. Upon such cancellation or upon the expiration of the time stated therein, the structure or structures shall be promptly removed.

**Section 5-3-5. Separate permit; required.**

A separate permit shall be required for each building or structure, provided that one permit may be obtained for:

- (1) Building or constructing a dwelling and its accessories, such as a fence, wall, pool, and a garage;
- (2) Electrical work for a dwelling and a private garage, shed, or accessory building located on the same premises as the main building, and supplied electrical power by a feeder or circuit from the main building; and
- (3) Plumbing work for a dwelling and a private garage, shed, or accessory building located on the same premises as the main building and served by the same building water supply and building sewer as that serving the main building.

**Division 2. Permits not required.**

**Section 5-3-21. Permit exemptions.**

- (a) Any person who is undertaking an action that is exempted from the requirement for a permit may be required to obtain a declaration from the authority having jurisdiction that the proposed action:
  - (1) Is exempt from the requirement to obtain a permit;
  - (2) Complies with chapter 27, relating to flood control; and
  - (3) Complies with chapter 205A, Hawai‘i Revised Statutes, relating to special management areas.
- (b) Exemption from the permit requirements of the construction code shall not be deemed to authorize violation of other provisions of this code or other applicable laws.

**Section 5-3-22. Building work; exempt.**

- (a) A permit shall not be required for any of the following building work, provided no electrical work or plumbing work is proposed:
  - (1) Installation and/or construction of:
    - (A) Awnings projecting up to four feet and attached to the exterior walls of buildings of Group R-3 or U Occupancy; provided that the awnings do not violate the provisions for “yards” in chapter 25 (zoning), Hawai‘i County Code; or
    - (B) Cabinets or wall mounted shelving not affecting fire resistance or structural members of walls for R-3 Occupancy and individual units of R-1, R-2, and U Occupancies which are not regulated under cooking unit clearances of the construction code. Cooking unit clearances refers to clearances between cooking surfaces and combustible materials, including but not limited to cabinets; or
    - (C) Detached decks or platforms that are less than thirty inches in height above grade. Buildings cannot violate the provisions for “yards” in chapter 25 (zoning). Verify setback requirements with the planning department; or

- (D) Detached one-story accessory structures of U occupancy, used as a tool shed, storage shed, gazebo, playhouse, animal shed, or for a similar use, provided:
  - (i) The structures are located on residential zoned land;
  - (ii) The total floor area of the accessory structures does not exceed two hundred square feet and is not greater than fifteen feet above finish grade; and
  - (iii) The building is not located less than ten feet from the property line or other structures; and does not violate the provisions for “yards” in chapter 25 (zoning). Structures shall be limited as defined per chapter 25; or
- (E) Standard electroliers not over thirty-five feet in height above finish grade; or
- (F) Fences six feet or less in height; or
- (G) Floor covering; or
- (H) Playground equipment, excluding assembly or similar waiting areas; or
- (I) Re-roofing work with like material and installation of siding to existing exterior walls which will not affect the structural components of the walls for Groups R-3 and U Occupancies; or
- (J) Wallpaper or wall coverings which are exempted under the provisions of section 801.1, Interior Finishes, chapter 8, IBC; or
- (K) Water features and swimming pools less than twenty-four inches in depth, for one and two-family dwelling units; or
- (L) Wells and reservoirs pursuant to chapter 178, Hawai‘i Revised Statutes; or
- (M) Television and radio equipment (i.e. antenna, dishes) accessory to R-3 Occupancies. Supports or towers for television and radio equipment six feet or less in height; or
- (N) Air conditioners that are: in Residential R-3 Occupancy, window-mounted, and do not impair emergency egress; or portable air conditioning systems; or
- (2) Installation and/or construction of temporary tents or other coverings used for private family parties or for camping on approved campgrounds, in accordance with article 4 (camping), and article 5 (picnics) of chapter 5; or
- (3) Painting and decorating; or
- (4) Repairs, excluding any installation or construction work otherwise exempted in subsection (a), that involve only the replacement of component parts or existing work with similar materials for the purpose of maintenance and do not cost over \$7,500 per structure in any twelve-month period, and do not affect or modify any existing electrical or mechanical installations. Repairs that cost over \$7,500 per structure in any twelve-month period or that include additions, changes, or modifications to construction or structures, exit facilities, permanent fixtures, or equipment shall not be exempted from this section; or

- (5) Replacement of solar water heating components (i.e. panels, tanks) in the same location and of the same type; or
  - (6) Agricultural buildings, structures, and appurtenances exempt from building permit and building code requirements pursuant to section 46-88, Hawai'i Revised Statutes; or
  - (7) Work located primarily in a public way, public utility towers, bridges, poles, mechanical equipment not specifically regulated in the construction code, and hydraulic flood control structures; or
  - (8) Work performed under the jurisdiction or control of the:
    - (A) State department of transportation at state harbors, pursuant to section 266-2, Hawai'i Revised Statutes; or
    - (B) State department of accounting and general services.
- (b) The foregoing exemptions from permit requirements shall not be deemed to:
- (1) Allow any building work to be done in a manner contrary to other provisions of the construction code; or
  - (2) Authorize violation of article 3, pertaining to other work, or of other applicable laws.

**Section 5-3-23. Electrical work; exempt.**

- (a) A permit shall not be required for the following electrical work:
- (1) Electrical work and installations to which the provisions of this chapter and chapter 5D, the electrical code, are expressly declared to be not applicable.
  - (2) Existing electrical installations which complied with the applicable laws in effect when the electrical work thereon was performed, provided that such installations shall be subject to the provisions of section 5D-2-3.
  - (3) Installation of any portable motor or other portable appliance energized by means of a cord or cable, having an attachment plug, if such cord or cable is permitted by chapter 5D, the electrical code.
  - (4) Repair of any fixed motor, water heater, air conditioning controls, or other appliance, or replacement of any fixed motor with another having the same horsepower rating and situated at the same location.
  - (5) Replacement of receptacles and switches to tamper-resistant receptacles and switches.
  - (6) Maintenance work by a licensed electrician pursuant to chapter 448E, Hawai'i Revised Statutes, provided, that maintenance work that involves or requires the repair, replacement, or rearrangement of wiring does require a permit as it is not included in this exemption.
- (b) The provisions of the foregoing exemptions shall not apply to any repairs or replacement of electrical devices, apparatus, or appliances which were originally

installed without a permit, when such permit is required for the original installation, or when energized by or a part of any hazardous or illegal wiring system.

- (c) The foregoing exemptions from permit requirements shall not be deemed to:
  - (1) Allow any electrical work to be done in a manner contrary to other provisions of the construction code; or
  - (2) Authorize violation of chapter 5D, the electrical code, or other applicable laws.

**Section 5-3-24. Plumbing work; exempt.**

- (a) A permit shall not be required for the following plumbing work:
  - (1) Plumbing work and installations to which the provisions of this chapter and chapter 5F, the plumbing code, are expressly declared to be not applicable.
  - (2) Clearing stoppages or repairing leaks in pipes, valves, or fixtures, when such repairs do not involve or require the replacement or rearrangement of valves, pipes, or fixtures.
  - (3) Replacement or repair of disposals, faucets, and fixtures, to include sinks and water closets, for non-commercial residential and County of Hawai'i government occupancies only. Repairs that involve or require the replacement or rearrangement of valves or pipes do require a permit as they are not included in this exemption. All repair or replacement work shall be done by licensed plumbers in accordance with section 444, Hawai'i Revised Statutes.
  - (4) Maintenance work by a licensed plumber pursuant to chapter 448E, Hawai'i Revised Statutes, provided, maintenance work that involves or requires the repair, replacement, or rearrangement of valves or pipes requires a permit as it is not included in this exemption.
- (b) The foregoing exemptions from permit requirements shall not be deemed to:
  - (1) Allow any plumbing work to be done in a manner contrary to other provisions of the construction code; or
  - (2) Authorize violation of chapter 5F, the plumbing code, or other applicable laws.

**Section 5-3-25. Emergency work.**

- (a) Emergency work may commence in compliance with section 5-4-2, without a permit. However, the applicant shall notify the authority having jurisdiction of such emergency work on the workday immediately following the day the emergency work is commenced. This notification shall be made in writing. An application for a permit for the emergency work shall be filed with and appropriate fees, pursuant to 5-7-3, paid to the authority having jurisdiction within fourteen days of the commencement of the emergency work. The authority having jurisdiction may grant one or more extensions of time for additional periods not exceeding fourteen consecutive days each. Prior to the deadline, requests for extension shall be filed in writing with the authority having

jurisdiction, and demonstrate that circumstances beyond the applicant's control justify granting the extension request. This provision shall pertain to the following types of work:

- (1) Emergency building work including the repair of any legally erected existing structure that was damaged during an emergency. The damage resulting from the emergency must be to an extent that it requires immediate action to prevent substantial physical harm to persons or property. As used in this section, "repair" means any restoration, reconstruction, or other work performed to return a structure to its former condition that does not increase the floor area of the structure beyond that of the structure prior to the major disaster, and is in conformance with the construction code, flood hazard regulations, land use ordinances, and other applicable laws.
  - (2) Emergency electrical work, including work on electrical wiring to restore electrical service to a building following a fire, to remedy a power failure, and to protect persons and property against short circuiting and open circuits.
  - (3) Emergency plumbing work, including work to remedy leaks in drains, soil, waste, vent pipes, or conditions that are otherwise dangerous to human health or public welfare.
- (b) A one-time emergency inspection may be conducted to verify that the immediate threat to public health, life and safety has been remedied. Upon issuance of the emergency work permit pursuant to subsection (a), regular inspections shall be conducted pursuant to sections 5-8-4 and 5-8-5.
- (c) This section shall not be interpreted to authorize violation of other provisions of the construction code or other applicable laws. Structures or portions thereof that were illegally erected or constructed shall not be repaired under this section.

#### **Article 4. Permit Application.**

##### **Division 1. Application.**

###### **Section 5-4-1. Application for permit.**

- (a) To obtain a permit, an applicant shall file an application in writing or online on a form furnished by the authority having jurisdiction for that purpose. Applications shall:
- (1) Identify and describe the work to be covered by the permit for which the application is made and the owner of the property;
  - (2) Describe the property on which the proposed work is to be done in sufficient detail to determine the precise location of the property involved, including legal description, tax map key number, street address, or similar description that will readily identify and definitely locate the proposed building or work;

- (3) Indicate the use and occupancy for which the proposed work is intended;
  - (4) Be accompanied by plans, specifications, construction documents and other information as required in this article;
  - (5) If submitting plans, specifications, or construction documents pursuant to section 464-13(b), Hawai'i Revised Statutes, the applicant shall include proof of recordation with the bureau of conveyances in accordance with section 464-13(c), Hawai'i Revised Statutes;
  - (6) State the estimated value of the proposed work;
  - (7) Indicate that the owner or the owner's authorized agent consents to the permit application, by inclusion of the owner or the owner's authorized agent's signature on the application;
  - (8) Declare the phases of work, if any, that will be performed by a contractor or specialty contractor, or both, as required by law;
  - (9) Provide the name and license number of all specialty contractors involved in the project, in compliance with the provisions of chapter 444, Hawai'i Revised Statutes;
  - (10) Be signed by the responsible managing employee or authorized employee of each contractor designated in paragraphs (8) and (9);
  - (11) Provide email and telephone number of applicant or agent;
  - (12) Include a non-refundable permit plan review fee pursuant to section 5-7-1; and
  - (13) Contain any other information necessary to enforce the provisions of the construction code as may be required by the authority having jurisdiction.
- (b) Applications and required documents shall be filed in writing. After the authority having jurisdiction implements its electronic filing system, applicants may submit documents in writing or electronically.
- (c) Applications that do not conform to the provisions of division 2 shall not be accepted by the authority having jurisdiction.

**Section 5-4-2. Plans, specifications, and other data.**

- (a) The following documents shall be submitted with each application for a permit: plans; specifications; engineering calculations; diagrams; soil investigation reports; code search; special inspection and structural observation programs; and other data as may be required by the authority having jurisdiction.
- (b) Number of sets of documents to be submitted with each application:
  - (1) Two sets for single and two-family dwellings or town houses (R-3 Occupancy);
  - (2) Two sets for accessory structures; and
  - (3) Three sets for all other occupancies.

- (c) Plans and specifications shall:
- (1) Be drawn to scale upon substantial paper that is of sufficient size that the plans and specifications when in print form, are legible without magnification;
  - (2) Be of sufficient clarity to indicate the nature and extent of work proposed and show in detail that it will conform to the provisions of the construction code and all applicable laws;
  - (3) Display the following information on the first sheet of each set of plans:
    - (A) The tax map key number of the job site;
    - (B) The name and address of the owner as referenced on real property records;
    - (C) The name and address of the person who prepared the plans;
    - (D) The following code search information:
      - (i) The basis of the building design including but not limited to the following: type of construction; occupancy; basic allowable floor areas; separation for mixed occupancy; number of occupants, wind speed (basic, effective), wind exposure, seismic zone, and exposure, etc. In lieu of detailed specifications, the authority having jurisdiction may approve references on the plans to a specific section or part of the construction code or other ordinances or laws;
      - (ii) Calculations, stress diagrams, and other data sufficient to show the correctness of the plans, shall be submitted when required by the authority having jurisdiction;
      - (iii) All plans other than R-3 and U occupancies shall have on the plans information of occupancy, type of construction, floor area computations, allowable area increases, separation wall if used, fire resistive substitution, fire sprinkler, exits, etc.;
      - (iv) Code search information for building design; and
      - (v) Additional forms required in the construction code; and
    - (E) Floor area computations, including major and accessible floor area, that are clearly labeled; and
  - (4) Include a plot plan showing the location of:
    - (A) The proposed building;
    - (B) Every existing building and/or structure on the property, including but not limited to retaining walls, water tanks, pools, etc.;
    - (C) Distances between buildings;
    - (D) Setbacks; and
    - (E) Certified flood zone elevation mark, as applicable.

**Section 5-4-3. Engineers and architects; work.**

- (a) All plans and specifications relating to work which affects the public safety or health and for which a permit is required shall be prepared, designed, and stamped by a duly licensed architect or professional engineer in the State of Hawai'i in accordance with

chapter 464, Hawai'i Revised Statutes and 16-115, Hawai'i Administrative Rules unless the work is exempt pursuant to section 464-13(b), Hawai'i Revised Statutes.

- (b) The following plans and specifications shall be prepared, designed, and stamped by a person who is licensed in the State of Hawai'i as an architect or professional structural engineer:
  - (1) All wood trusses of more than 24'-0" spans; and
  - (2) All pre-engineered trusses and metal trusses.
  
- (c) For residential (R-3 Occupancies) and accessory (U Occupancies) only, the following plans and specifications shall be prepared, designed, and stamped by a person who is licensed in the State of Hawai'i as an architect or professional structural engineer, unless exempt pursuant to section 464.13(b), Hawai'i Revised Statutes. Whenever the exemption provided for in section 464.13(b) is applied to the construction of a new building, the applicant shall include with the application, proof that the exemption has been recorded with the bureau of conveyances pursuant to section 464-13(c), Hawai'i Revised Statutes.
  - (1) All plans for post and pier type construction with/without perimeter foundation walls of R-3 Occupancies.
  - (2) Single story or two-story structure for R-3 Occupancy unless exempt pursuant to section 464.13(b), Hawai'i Revised Statutes.
  - (3) Single story or two-story structure of mixed occupancies (R-3 and U Occupancies) pursuant to section 464.13(b), Hawai'i Revised Statutes.
  - (4) Structures of R-3 or U Occupancies that are three or more stories in height.
  - (5) Structural members that are concrete, masonry or structural steel.
  - (6) Proposed construction in special hazard flood zones: AE, AH, AO, V, and VE, as prescribed in chapter 27, relating to flood control; electrical installations per chapter 5D, relating to the electrical code; and plumbing installations per chapter 5F, relating to the plumbing code.
  - (7) Structures in high seismic zones. (Category E or  $S_v > 0.75$ )
  
- (d) All plans and specifications for retaining walls over four feet in height shall be prepared, designed, and stamped by a person who is licensed in the State of Hawai'i as an architect or professional structural engineer.
  
- (e) Electrical plans and specifications giving such details of the proposed installation as may be required by the authority having jurisdiction to be submitted with the application. Such plans and specifications shall be prepared, designed, and stamped by a person who is licensed in the State of Hawai'i as a professional electrical engineer.  
Exception:

For single and two-family dwellings, townhouses and accessory structures, plans and specifications shall not be required provided the installation meets all of the following criteria:

- (A) The installation shall not be located in a rain water or sea water flood zone; and
  - (B) Service size disconnect does not exceed 200 amperes.
- (f) Installation of photovoltaic systems shall require:
- (1) Electrical design drawings and specifications that have been prepared, designed, and stamped by a person who is licensed in the State of Hawai'i as a professional electrical engineer for residential and non-residential installations; and
  - (2) Plans and specifications for building work that have been prepared, designed, and stamped by a person who is licensed in the State of Hawai'i as an architect or a professional structural engineer for:
    - (A) Non-residential installations; or
    - (B) Residential installations that do not utilize a preapproved system or that are not consistent with approved standards including but not limited to, those relating to span tables, older homes or site-built trusses.
- (g) Installation of electrical work on residential and nonresidential electrical work in special flood hazard areas shall be prepared, designed, and stamped by a person who is licensed in the State of Hawai'i as a professional electrical engineer.
- (h) Mechanical plans, included but not limited to plumbing installation and HVAC installation drawings, specifications shall be prepared, designed, and stamped by a person who is licensed in the State of Hawai'i as a professional mechanical engineer, and shall be according to State statutes when required by the authority having jurisdiction. Plans for single- or two family dwellings are not required to show plumbing piping plans or diagrams unless requested by the authority having jurisdiction.
- Exception:  
For single and two-family dwellings and residential accessory structures, plans and specifications may be prepared, designed, and stamped by a person who is licensed in the State of Hawai'i as an architect or professional mechanical engineer.
- (i) Plumbing plans and diagrams shall be required for R-3 single and two family dwellings and townhouses that include four or more bathrooms.
- (j) The authority having jurisdiction may require plans, computations, and specifications to be prepared, designed, and stamped by a person who is licensed in the State of Hawai'i as an architect or professional engineer, if prescriptive requirements of the construction code are not being adhered to.

- (k) No person shall materially deviate from any reviewed plan or specifications or fail, neglect or refuse to comply herewith, unless permission to do so has first been obtained from the person who is licensed in the State of Hawai‘i and listed as the architect or professional engineer of record. Revised drawings or a letter, or both, that show such deviations and have have been prepared, designed, and stamped by the architect or professional engineer of record, shall be submitted to the authority having jurisdiction for review and approval.

**Section 5-4-4. Contractors and specialty contractors; work.**

- (a) Prior to issuance of a permit, applicants for a permit shall file a statement with the authority having jurisdiction that includes the following:
  - (1) Name; address, email address and telephone number of each contractor or specialty contractor engaged to work upon the building, structure, or project;
  - (2) Name of the responsible managing employee or authorized employee of each contractor or specialty contractor;
  - (3) Phase or phases of work to be performed by each contractor or specialty contractor;
  - (4) License numbers for each contractor or specialty contractor and a statement that such licenses are in full force and effect, or if the applicant is exempt from chapter 444, Hawai‘i Revised Statutes, the basis for the claimed exemption, pursuant to section 444-9.1, Hawai‘i Revised Statutes; and
  - (5) A signature by the responsible managing employee or authorized employee of each contractor and specialty contractor.
- (b) Whenever used in this section, in accordance with section 444-7, Hawai‘i Revised Statutes, “specialty contractor” means a contractor whose operations as such are the performance of construction work requiring special skill such as, but not limited to, electrical, drywall, painting and decorating, landscaping, flooring, carpet laying by any installation method, plumbing, or roofing work, and others whose principal contracting business involves the use of specialized building trades or crafts.

**Section 5-4-5. Review of application.**

- (a) The application, plans, specifications, and other data filed by an applicant for a permit shall be reviewed by the authority having jurisdiction. Plans shall also be reviewed by other appropriate departments and divisions of the County and the State to verify compliance with laws under their jurisdiction.
- (b) Nothing contained in the construction code shall be construed to require the authority having jurisdiction to accept or reject any permit application before completion of reviews required pursuant to the construction code and other applicable laws.

**Section 5-4-6. Action on application.**

- (a) If the application, plans, specifications, and other data filed by an applicant for a permit do not conform to the requirements of pertinent laws, the authority having jurisdiction shall reject such application in writing, stating the reasons therefor.
- (b) If the authority having jurisdiction finds that the work described in an application for a permit and the plans, specifications and other data filed therewith conform to the requirements of the construction code and all other pertinent laws, and the fees specified in article 7 have been paid, the authority having jurisdiction shall issue a permit therefor to the applicant.

**Section 5-4-7. Cancellation of application.**

- (a) Thirty days to pick up permit or plan review letter.  
Upon notice to applicant that their application is ready for pick up with either a "recommend for issuance" or "recommend return with correction," the applicant shall have thirty working days to pick up their permit or application respectively. If the permit application is not picked up within thirty working days, the application will be canceled. The thirty-day period will begin on the working day following the day that notification is electronically sent to the applicant.
- (b) Sixty days to take action on deficient application.  
If an applicant picks up an application designated "recommend return with correction," the applicant shall have sixty working days to take action on the deficiencies noted in the application. The sixty-day period will begin on the working day following the day the application is picked up.
- (c) 180 days to obtain permit.  
An application for a permit shall be deemed to have been canceled 180 days after the date of filing, unless such application has been pursued in good faith or a permit has been issued. The authority having jurisdiction may grant one or more extensions of time for additional periods not exceeding ninety consecutive days each. Prior to the deadline, requests for extension shall be filed in writing with the authority having jurisdiction, and demonstrate that circumstances beyond the applicant's control justify granting the extension request.
- (d) Restarting permit application.  
If a permit application is canceled, the application process must be restarted. In order to restart an application after its cancellation, the applicant shall resubmit plans with alterations to meet current codes and pay a new plan review fee.
- (e) If an application is canceled, plans and other data submitted for review may thereafter be returned to the applicant or destroyed by the authority having jurisdiction.

**Section 5-4-8. Applications made prior to subsequent changes in applicable laws.**

An applicant for a permit who has filed an application with the authority having jurisdiction prior to the effective date of a subsequent change in applicable law shall be required to obtain the permit no later than one hundred eighty consecutive days after the effective date of such law. If the permit has not been obtained within one hundred eighty consecutive days after the effective date of the subsequent law, the application and plans shall comply with the requirements set forth in the subsequent law. Where the subsequent law specifies a time period for obtaining a permit other than the one hundred eighty-day period stated above, the time period specified in the subsequent law shall govern.

**Division 2. Pre-approval.**

**Section 5-4-21. Model plans for residential dwellings; pre-approval.**

(a) Model plan pre-approval.

Model plans for residential dwellings may be pre-approved by the authority having jurisdiction. The application process for a permit that is based on model plans for residential dwellings that have been pre-approved and filed with the authority having jurisdiction shall exclude the plan and specification review required in sections 5-4-1 and 5-4-2. This exemption shall not apply to reviews by other appropriate departments and divisions of the County and the State required pursuant to subsection 5-4-5.

(b) Model home designs.

(1) Eligible model home designs shall have no limitation on size.

Exception:

A maximum of a two-car carport/garage may be included.

(2) Layouts of plans that are mirrored or reversed versions of previously approved plans, will be considered to be separate and an additional model home design subject to paragraph (1) of this subsection.

(3) Any revisions to pre-approved plans will require resubmittal of the entire set of revised plans and documents for approval. A proposed revision to an already pre-approved plan will be considered to be a separate and an additional home design subject to paragraph (1) of this subsection.

(c) Application for model plan pre-approval.

(1) To apply for pre-approval of a model plan, three sets of complete working drawings and specifications that bear the wet seal and signature of a person who is licensed in the State of Hawai'i as an architect or professional structural engineer shall be submitted to the authority having jurisdiction.

(2) Factory-built homes shall include a manufacturer's seal as required by Appendix L of chapter 5A, the building code.

- (3) A plan review fee for pre-approved model plans shall be assessed per model home design in accordance with section 5-7-2.
- (d) The authority having jurisdiction shall approve the application, and assign a model number to the pre-approved model plan, if it finds that:
  - (1) The plans submitted for pre-approval conform with the requirements of the construction code and with all other applicable laws; and
  - (2) The fees specified in section 5-7-2 have been paid.
- (e) Expiration of model plan pre-approval.  
Pre-approved model plans for home designs shall remain valid until a new edition of the model building code is adopted by the authority having jurisdiction.
- (f) Owner/contractor application for permit.
  - (1) When applying for a permit with a pre-approved plan for a model home design the owner/contractor shall:
    - (A) Submit two sets of complete working drawings showing the pre-approved model number along with the manufacturer's wet seal and authorizing signature. The authority having jurisdiction will verify the seal and signature.
    - (B) Pay the permit plan review fee pursuant to section 5-7-1.
    - (C) Obtain required approvals from other departments or agencies.
  - (2) Construction drawings for pre-approved model home designs, with the exception of the plot plan and/or cover sheet will not be required to be individually stamped by a person who is licensed in the State of Hawai'i as an architect or professional structural engineer in accordance with this chapter and chapter 464, Hawai'i Revised Statutes. The plot plan and/or cover sheet shall bear the same architect or professional engineer's wet seal or signature as submitted on the pre-approved model home design, pursuant to subsection (c)(1).
  - (3) After the requisite approvals from other departments or agencies have been obtained, the authority having jurisdiction will either approve the application or inform the applicant of deficiencies in the application within six working days after the authority having jurisdiction receives notice that all approvals have been obtained.
  - (4) Once approved, the authority having jurisdiction shall issue the permit in accordance with section 5-5-1.

## **Article 5. Permits.**

### **Section 5-5-1. Issuance.**

- (a) Permits shall be issued in such form and detail as shall be prescribed by the authority having jurisdiction. They shall specify the geographical location of the premises whereon the work authorized thereby is to be done, be valid only for the location so specified, and be endorsed in writing or stamped on all sets of plans and specifications "REVIEWED."
- (b) Once a permit is issued, plans and specifications shall not be changed, modified, or altered without authorization from the authority having jurisdiction, and all work shall be done in accordance with the approved plans.
- (c) The authority having jurisdiction may issue a permit for the construction of part of the building or structure before complete plans and specifications for the whole building or structure have been submitted or approved, provided adequate information and detailed statements have been submitted that are sufficient to indicate compliance with all pertinent requirements of the construction code. The holder of such permit shall proceed at the holder's own risk, without assurance that the permit for the entire building or structure will be granted.
- (d) The issuance of a permit shall not prevent the authority having jurisdiction from thereafter:
  - (1) Requiring the correction of errors in the plans and specifications;
  - (2) Revoking or suspending any permit when issued in error, on the basis of incorrect information supplied, or in violation of the construction code, any permit or variance issued pursuant to the construction code, or other applicable law;
  - (3) Halting building operations when in violation of the construction code, any permit or variance issued pursuant to the construction code, or other applicable law;
  - (4) Preventing occupancy or use of a structure, when violations of the construction code, any permit or variance issued pursuant to the construction code, or other applicable law have occurred; or
  - (5) Initiating criminal enforcement and the imposition of penalties or fees, or both, when authorized by the construction code or other applicable law.

### **Section 5-5-2. Posting.**

Work requiring a permit shall not be commenced until the permit holder or their agent shall have posted the permit in a conspicuous place on the job site. The permit shall be readily visible for the authority having jurisdiction to identify and make all required inspections. The permit shall remain posted in a conspicuous place on the job site until the work has passed a final inspection by the authority having jurisdiction. Failure to comply with this provision shall subject the violator to a \$100 fine.

**Section 5-5-3. Designation of person, contractor, or subcontractor who will do work.**

- (a) No permit issued shall authorize any person or contractor to work upon any phase of a building, structure, or project unless they have been specifically identified in the permit application, including any attachment or amendments thereto, as the contractor or subcontractor designated to do that particular phase of work.
- (b) No permit shall be loaned to another by the person to whom it was issued.
- (c) If subsequent to the issuance of a permit, a homeowner either ceases to employ the owner-builder exemption and engages a contractor for any phase of work, or there is a change in the designation of any contractor for any phase of work, the permit holder shall file a written request to the authority having jurisdiction for approval of these changes. The request shall include: the change in designation; a revised declaration form for each contractor or subcontractor engaged to do electrical or plumbing work upon the building, structure, or project; and a non-refundable fee of \$100.

**Section 5-5-4. Expiration.**

- (a) Permits shall expire and become null and void:
  - (1) Permits issued to contractors - three years after the date of issuance of the permit;
  - (2) Permits issued to owner-builders - five years after the date of issuance of the permit;
  - (3) 180 consecutive days after the date of issuance, if the work authorized by the permit is not commenced by such date; or
  - (4) If the work authorized by a permit is suspended or abandoned for a period of 180 consecutive days or more at any time after the date of issuance.
- (b) Upon expiration of a permit, all work shall cease and shall not be recommenced until a new permit is obtained.

**Section 5-5-5. Extension.**

- (a) In the event of a strike or some other event beyond the control of the contractor or the owner that results in the suspension or abandonment of construction, the authority having jurisdiction may extend the deadlines for construction. An extension of time may be granted for the length of time that work has been halted by strikes or other causes beyond the control of the owner or contractor but in no case shall the extension exceed 180 consecutive days.
- (b) Requests for extension shall be filed in writing with the authority having jurisdiction prior to the deadlines specified in section 5-5-4 and within seven calendar days after the commencement of the delay. The written application shall describe in detail the causes

of the delay, the effect on the performance of work, the time during which work was actually suspended, and the portion or portions of the project affected.

- (c) The authority having jurisdiction shall maintain accurate records of all written requests for extension and their subsequent disposition. Said records shall contain the name of the applicant, location of the project and a detailed written explanation of the reasons for granting or denying the request for extension.

**Section 5-5-6. Retention of plans.**

One set of approved plans, specifications, and computations shall be retained by the authority having jurisdiction for a period of not less than ninety calendar days from the date of completion of the work covered therein. In addition, one set of approved plans shall be returned to the applicant and shall be kept on the job site at all times during which the work authorized thereby is in progress.

**Article 6. Eligibility to Work.**

**Section 5-6-1. Persons to whom a permit may be issued.**

- (a) A permit to do building work regulated by the construction code may be issued only to:
  - (1) A contractor or specialty contractor who is licensed pursuant to chapter 444, Hawai‘i Revised Statutes; or
  - (2) An “owner-builder” pursuant to the owner-builder exemption as defined by section 444-2.5, Hawai‘i Revised Statutes.
  
- (b) A permit to do electrical work regulated by the construction code, may be issued only to:
  - (1) An electrical contractor licensed pursuant to chapter 444, Hawai‘i Revised Statutes;
  - (2) A homeowner for electrical work on a single-family dwelling which the homeowner will personally occupy and use exclusively for living purposes, provided the homeowner is a journey worker electrician, journey worker specialty electrician, supervising electrician, or supervising specialty electrician licensed pursuant to chapter 448E, Hawai‘i Revised Statutes. Only one such permit may be issued to such homeowner unless the authority having jurisdiction finds that strict application of this provision would result in practical difficulty and hardship and that the granting of a second permit would not be contrary to the purpose of the construction code. This does not preclude the homeowner from obtaining additional permits for the same building or accessory building on the same lot;

- (3) A supervising electrician or supervising specialty electrician licensed pursuant to chapter 448E, Hawai‘i Revised Statutes:
    - (A) Who is employed as a maintenance electrician by someone other than a contractor described above;
    - (B) Who is employed by the County or State; or
    - (C) Who is applying for electrical work for such person’s own dwelling; or
  - (4) A journey worker electrician licensed pursuant to chapter 448E, Hawai‘i Revised Statutes, and employed by the County of Hawai‘i.
- (c) A permit to do plumbing work regulated by the construction code may be issued only to:
- (1) A plumbing contractor licensed pursuant to chapter 444, Hawai‘i Revised Statutes;
  - (2) A homeowner for plumbing work on a single-family dwelling which the homeowner will personally occupy and use exclusively for living purposes, provided the homeowner is licensed pursuant to chapter 448E, Hawai‘i Revised Statutes. Only one such permit may be issued to such a homeowner, unless the authority having jurisdiction finds that strict application would result in practical difficulty and hardship and that the granting of a second permit would not be contrary to the purposes of the code. This does not preclude the homeowner from obtaining additional permits for the same building or accessory building on the same lot;
  - (3) A master plumber licensed pursuant to chapter 448E, Hawai‘i Revised Statutes:
    - (A) Who is employed as a maintenance plumber by someone other than a contractor described above;
    - (B) Who is employed by the County or State; or
    - (C) Who is applying for plumbing work for such person’s own dwelling; or
  - (4) A journey worker plumber licensed pursuant to chapter 448E, Hawai‘i Revised Statutes, and employed by the County of Hawai‘i or by a gas utility.

**Section 5-6-2. Eligibility to perform work.**

- (a) Except as otherwise provided in this section, work regulated by the construction code shall be performed only by:
  - (1) A contractor licensed pursuant to chapter 444, Hawai‘i Revised Statutes; or
  - (2) An “owner-builder” pursuant to section 444-2.5, Hawai‘i Revised Statutes.
- (b) Electrical work regulated by the construction code, and specifically chapter 5D, the electrical code, shall be performed only by:
  - (1) A journey worker electrician, journey worker specialty electrician, supervising electrician, or supervising specialty electrician license licensed pursuant to chapter 448E, Hawai‘i Revised Statutes; or

- (2) A homeowner for electrical work on a single-family dwelling which the homeowner will personally occupy and use exclusively for living purposes, provided the homeowner is a journey worker electrician, journey worker specialty electrician, supervising electrician, or supervising specialty electrician licensed pursuant to chapter 448E, Hawai'i Revised Statutes.
- (c) Plumbing work regulated by the construction code, and specifically chapter 5F, the plumbing code, shall be performed only by:
  - (1) A master plumber or journey worker plumber licensed pursuant to chapter 448E, Hawai'i Revised Statutes; or
  - (2) A home owner for plumbing work on a single-family dwelling which the homeowner will personally occupy and use exclusively for living purposes, provided the homeowner is a master plumber or journey worker plumber licensed pursuant to chapter 448E, Hawai'i Revised Statutes.
- (d) No person shall allow any other person to do or cause to be done any work under a permit except individuals employed by the permit holder.

#### **Article 7. Fees.**

##### **Section 5-7-1. Permit plan review; general.**

- (a) A fee shall be assessed for plan reviews. The fee shall be in the amount of twenty percent of the permit fee, with a minimum fee of \$50 and shall accompany the application, plans, and specifications that are filed for review pursuant to section 5-4-1. Plan review fees shall be assessed in addition to the permit fee.
- (b) No additional plan review fee will be assessed for a second submittal. Plan review fees for subsequent submittals shall be: \$250 for a third submittal; \$500 for a fourth submittal; and \$1,000 for each additional submittal.
- (c) A fee shall be assessed for plan reviews resulting from revisions of permits that have already been issued, where a new permit is not required. The fee shall be in the amount of twenty percent of the original permit fee, or \$50, whichever is greater.

**Section 5-7-2. Plan review fee for pre-approved model plans for residential dwellings.**

A plan review fee shall be assessed on model plans for residential dwellings. Each unique model plan of a residential dwelling shall be subject to a separate fee. These one-time plan review fees shall be based on the schedule below.

<b>PLAN REVIEW FEE FOR PRE-APPROVED MODEL PLANS FOR RESIDENTIAL DWELLINGS (Per Unique Design)</b>	
<b>Category</b>	<b>Fees</b>
A. County of Hawai‘i, Department of Public Works, Building Division pre-approved single family dwelling with architect or structural engineer stamp 900 s.f. - 1,100 s.f. (living area only with one car or two car carport).	\$150
B. County of Hawai‘i, Department of Public Works, Building Division pre-approved single-family dwelling with architect or structural engineer stamp 1,101 s.f. - 1,400 s.f. (living area only with one car or two car carport).	\$200
C. Dwellings over 1,401 s.f. including all single-family model homes with no minimum s.f. requirement. (To include all enclosed areas under roof.)	\$20 per 100 sq. ft. or fraction thereof

**Section 5-7-3. Permit.**

- (a) A fee shall be assessed for each permit. The fee shall be submitted at the time of permit issuance. A permit shall not be valid until the fees prescribed by law have been paid, nor shall an amendment to a permit be released until any applicable additional fee, has been paid.
- (b) Fee Schedule. Permit fees shall be based on a schedule of fees applied to a valuation of average construction costs and shall be imposed in the amounts set out in the following table:

<b>PERMIT FEES</b>	
<b>General Construction</b>	
<b>Valuation</b>	<b>Fees</b>
\$0 to \$500	\$10
\$501 to \$2,000	\$10 for the first \$500 plus \$1.50 for each additional \$100 or fraction thereof, to and including \$2,000.
\$2,001 to \$25,000	\$32.50 for the first \$2,000 plus \$7.50 for each additional \$1,000 or fraction thereof, to and including \$25,000.
\$25,001 to \$50,000	\$205 for the first \$25,000 plus \$6 for each additional \$1,000 or fraction thereof, to and including \$50,000.
\$50,001 and up	\$355 for the first \$50,000 plus \$3 for each additional \$1,000 or fraction thereof.
<b>Other</b>	
Carport, garages, porches, patios or lanais and detached U structures.	\$10 per 100 sq. ft. or fraction thereof.

- (c) Valuation. The determination of average construction costs shall be based upon the most recent building valuation data published by the International Code Council, Inc., 4051 West Flossmoor Road, Country Club Hills, IL, 60478-5795. This valuation data is based on typical construction methods and for the purpose of determining permit fees necessary to fund code compliance activities.

The valuation shall consist of the total average construction cost, per square foot, of all construction work for which the permit is issued, including all finish work, painting, roofing, electrical, plumbing, heating, air conditioning, elevators, fire-extinguishing systems and any other permanent work, permanent equipment, or work exempt from permitting.

Differences in actual bids or contracts for specific construction projects and valuations derived from International Code Council building validation data, shall not invalidate the latter figure.

- (d) **Work Begun Without Permit.** When work for which a permit is required by the construction code has commenced without obtaining a permit, the fees shall be either \$1,000 plus the fees specified by this code, or the fees specified by this code shall be doubled, whichever is greater.

The payment of such fees shall not exempt any person from the requirements of the construction code in the execution of the work or from any other penalties prescribed in this code.

Exception:

This provision shall not apply to emergency work performed under circumstances that did not allow time to obtain a permit per section 5-3-25. To qualify for this exception, it must be proved to the satisfaction of the authority having jurisdiction that the unpermitted work was urgently necessary and that it was not practicable to obtain a permit therefore before the commencement of the work. In all such cases a permit must be obtained as soon as it is practicable to do so. Any delay in obtaining a permit as soon as it is practicable to do so will subject the petitioner to enhanced fees pursuant to section 5-7-3(d).

- (e) **New Permit Obtained After Expiration.** Where a new permit is obtained to complete construction of a project after expiration of permit under provisions of section 5-5-4, the fee therefor shall be based on the valuation of one-half the amount of work remaining to be done, provided:
  - (1) No change has been made or will be made in the original plans and specifications for such work;
  - (2) That immediately prior to applying for this permit the work on the property has not been abandoned or suspended for a period of more than one year; and
  - (3) No refund has been made under provisions of section 5-7-8.
- (f) To change the designation of contractor for any phase of work, pursuant to subsection 5-5-3(c), the fee shall be \$100.
- (g) The County and all contractors performing work under authority of the County shall be exempt from the requirement of paying any permit fee.
- (h) The following programs shall be exempt from the requirement of paying any permit fee, except for fees imposed pursuant to subsection (d), relating to work begun without

a permit and penalty fees when required by the construction code:

- (1) Habitat for Humanity - Hilo and Kona; and
  - (2) Hawai'i Community College's Model Home Project.
- (i) The authority having jurisdiction may waive permit fees for any person seeking to restore, reconstruct, or replace a structure damaged or destroyed as a result of a major disaster. For the purposes of this section, "major disaster" means any hurricane, tornado, storm, flood, high water, tsunami, earthquake, volcanic eruption, landslide, mud slide, fire, explosion, or other catastrophe occurring in any part of the County that causes damage, suffering, and loss to such a degree that:
- (1) The governor of the State of Hawai'i has declared pursuant to chapter 209, HRS, that a major disaster has occurred; or
  - (2) The mayor has issued a proclamation declaring the existence of a major disaster.

**Section 5-7-4. Temporary permit.**

A fee of \$50 shall be assessed for each temporary permit. The fee shall be submitted with the temporary permit application. A temporary permit shall not be valid until the fees prescribed by law have been paid.

**Section 5-7-5. Extra or regulatory inspections.**

- (a) A fee of \$100 shall be assessed upon the permit holder or requestor for each extra inspection made. As used in this section, unless the context otherwise requires, "extra inspection" means an inspection needed because the work to be inspected was not complete or ready for inspection during a previous inspection.
- (b) A fee of \$100 shall be assessed upon the requestor or property owner for each regulatory inspection made.
- (c) The authority having jurisdiction has the authority to waive inspection fees.

**Section 5-7-6. Temporary certificate of occupancy.**

Pursuant to section 5-8-22(c) a \$200 fee shall be assessed upon issuance of a temporary certificate of occupancy.

**Section 5-7-7. Fee payment.**

Fees imposed pursuant to this article shall be paid to the director of finance.

**Section 5-7-8. Refunds.**

Plan review fees are non-refundable. Permit fees may be partially refunded in accordance with section 2-12, Hawai'i County Code.

## **Article 8. Inspections.**

### **Division 1. General provisions.**

#### **Section 5-8-1. General requirements.**

- (a) All construction or work for which a permit is required shall be inspected by the authority having jurisdiction to ensure compliance with the requirements of the construction code. Approval as a result of an inspection shall not be construed to approve violations of the provisions of the construction code, or of any other laws. Inspections that either presume to authorize violations of or to nullify the provisions of the construction code or of other laws shall not be valid.
- (b) It shall be the duty of the permit holder or their agent, to cause the work to remain accessible and exposed for inspection purposes. Neither the authority having jurisdiction nor the County shall be liable for any expense entailed in the removal or replacement of any material required to allow inspection of construction or work, or to survey a lot.
- (c) The authority having jurisdiction may require a survey of the lot to verify that the approved plans accurately reflect the location of the structure.

#### **Section 5-8-2. Work shall be visible for inspection.**

- (a) No person shall:
  - (1) Conceal, enclose, or cover or cause or permit to be concealed, enclosed, or covered, any portion of any work or equipment for which a permit is required by the construction code, in any manner that will interfere with or prevent the inspection and approval thereof; or
  - (2) Remove any notice not to conceal, enclose or cover any portion of any work or equipment, placed thereon by the authority having jurisdiction.
- (b) No work that is subject to the permitting provisions of the construction code, shall be covered or concealed until two working days after a scheduled inspection or until the authority having jurisdiction has approved the installation and given permission to cover or conceal the same. It shall be the duty of the permit holder or their agent to cause the work to remain accessible and exposed for inspection purposes.
  - (1) Residential Installations. In residential installations, if the permitted work is covered or concealed without an inspection, the contractor will provide verification that the concealed work complies with all the provisions of the construction code in a letter and an inspection report stamped and signed by the professional of record who is licensed in the State of Hawai'i, as an architect or professional structural engineer. Should the authority having jurisdiction condemn any of said work or equipment as not being in accordance with the

provisions of the construction code, notice in writing to that effect shall be given to the person doing the work authorized by the permit or posted at the job site.

- (2) Non-Residential Installations. In non-residential installations, no framing, electrical wiring, plumbing or mechanical ducts or equipment shall be covered or concealed until two working days have expired after the scheduled inspection or until the authority having jurisdiction has approved the installation, and given permission to cover or conceal the same. If the permitted work is covered or concealed without inspection, the contractor will provide verification that the concealed work complies with all the provisions of the construction code. Should the authority having jurisdiction condemn any of said work or equipment as not being in accordance with the provisions of the construction code, notice in writing to that effect shall be given to the person doing the work authorized by the permit or posted at the job site.
- (c) After inspection, if the authority having jurisdiction finds that the work does not conform in all respects with the provisions of the construction code, the work or equipment shall be altered or removed as required, and necessary changes shall be made so that all such work and equipment fully complies with the provisions of this code. These changes shall be completed within a reasonable amount of time thereafter. Further work may not be connected on or with the condemned work or equipment until these changes are made.
- (d) In default, the contractor or owner-builder shall be liable for the penalties provided in the construction code, resulting from violations of this article. Further, any and every owner, contractor, or other person engaged in construction of the building or structure, or otherwise, covering or allowing to be covered such portion of work or equipment, or removing any notice not to cover same placed thereon by the authority having jurisdiction shall likewise be liable for the penalties provided in the construction code.

**Section 5-8-3. Requests for inspection.**

- (a) Whenever any work regulated by the construction code, or any portion thereof, is ready for inspection, the person doing the work authorized by the permit shall file a request for inspection with the authority having jurisdiction. The request for inspection may be filed in writing via forms furnished by the authority having jurisdiction, in-person delivery, online, or facsimile transmittal. Alternatively, a request for inspection may be communicated by telephone, if allowed by the authority having jurisdiction.
- (b) It shall be the duty of the person doing the work authorized by the permit, to make sure that the work will stand the tests prescribed elsewhere in the construction code, before filing a request for inspection.

- (c) The request for inspection shall be filed with the authority having jurisdiction not less than two working days and not more than three working days before any such inspection is desired.
- (d) Within two working days after receipt of such request, not including weekends or holidays, the authority having jurisdiction shall either proceed with the inspection or arrange with the contractor to reschedule the inspection for a later date. This rescheduled inspection may take place beyond two working days after receipt of the request for inspection.

**Section 5-8-4. Inspections.**

- (a) The authority having jurisdiction, upon receipt of a request for an inspection from the permit holder or their agent, shall inspect the work as provided in this section and shall either approve that portion of the construction as completed or notify the permit holder or the permit holder's agent if the same fails to comply with the construction code.
- (b) Building work for which a permit is required, shall be inspected by the authority having jurisdiction to ensure compliance with the requirements of this chapter and specifically, chapter 5A, the building code. Inspections shall be conducted in accordance with the following:
  - (1) During inspections the contractor shall be present on the job site upon request of the authority having jurisdiction.
  - (2) Footing and foundation inspections shall be made after excavations for footings are complete and any required reinforcing steel is in place. For concrete foundations, any required forms shall be in place prior to inspection. Materials for the foundation shall be on the job, except where concrete is ready mixed in accordance with ASTM C 94, the concrete need not be on the job.
  - (3) Concrete slab and under-floor inspections shall be made after in-slab or under-floor reinforcing steel and building service equipment, conduit, termite spray, vapor barriers, piping accessories and other ancillary equipment items are in place, but before any concrete is placed or floor sheathing installed, including the subfloor.
  - (4) Framing inspections shall be made after the roof deck or sheathing, all framing, fireblocking and bracing are in place and pipes, chimneys and vents to be concealed are complete and the rough electrical, plumbing, heating wires, pipes and ducts are approved.
  - (5) Insulation inspections as required shall be made after the framing inspection and before the lathing inspection.
  - (6) Lathing inspections shall be made after all lathing and gypsum board, interior and exterior, and which are required to be fire-resistive are in place but before any plastering is applied or before gypsum board joints and fasteners are taped and finished.

Exception:

Lath and gypsum board installed in Group R, Division 3 and Group U Occupancies.

- (c) Electrical wiring for which a permit is required, shall be inspected by the authority having jurisdiction to ensure compliance with the requirements of chapter 5D, the electrical code, before being concealed, energized, or used. All fees required by the construction code shall be paid by the permit applicant prior to the energizing or use of such wiring.

Inspections shall be conducted in accordance with the following:

- (1) The supervising electrician or electrical contractor shall be present on the job site upon request of the authority having jurisdiction.
  - (2) No person shall use, operate, or maintain, or cause or authorize to be used, operated, or maintained, any electric wiring until it is approved.
  - (3) No serving agency shall supply or cause or authorize to be supplied, permanent electric energy to any electric service until the service has been inspected and approved by the authority having jurisdiction.
  - (4) Fixtures, appliances, devices, or equipment shall not be connected to any electric wiring until the rough electric wiring, including conductors, have been inspected and approved by the authority having jurisdiction.
  - (5) All obstructions, covers, plates, tapes, light fixtures, etc., that make a thorough inspection of electric wiring impracticable shall be removed upon notice (either verbal or in writing) to do so, and shall remain removed until the electric wiring has been inspected and approved.
  - (6) Permanent electrical service must be energized prior to requesting an electrical final inspection pursuant to section 5-8-5.
- (d) Plumbing, gas, and drainage systems for which a permit is required, shall be inspected by the authority having jurisdiction to ensure compliance with the requirements of the construction code and specifically chapter 5F, the plumbing code. All fees required by this code shall be paid by the permit applicant prior to the use of the plumbing system. Inspections shall be conducted in accordance with the following:
    - (1) During inspections the supervising plumber or plumbing contractor shall be present on the job site upon request of the authority having jurisdiction.
    - (2) No person shall use, operate, or maintain, or cause or authorize to be used, operated, or maintained, any plumbing system until it is approved.
    - (3) Fixtures, appliances, devices, or equipment shall not be connected to any plumbing system until the rough piping has been inspected and approved by the authority having jurisdiction.
    - (4) All obstructions, covers, plates, tapes, light fixtures, etc., that make a thorough inspection of the plumbing system impracticable shall be removed upon notice

(either verbal or in writing) to do so, and shall remain removed until the plumbing system has been inspected and approved.

- (e) Authority to proceed.  
After inspection, if the authority having jurisdiction finds that the work conforms in all respects with the provisions of the construction code, a notice granting authority to proceed with the work shall be given.
- (f) After inspection, if the authority having jurisdiction finds that the work does not conform in all respects to the provisions of the construction code, the work or equipment shall be altered or removed as required, and necessary changes shall be made so that all such work and equipment fully complies with the provisions of this code. These changes shall be completed within a reasonable amount of time thereafter. Further work may not be connected on or with the condemned work or equipment until these changes are made.
- (g) The authority having jurisdiction may request that at least one side of the enclosed walls of unpermitted structures be open, prior to inspection.

**Section 5-8-5. Final inspection.**

- (a) The final inspection shall be made after all work required by the permit is completed.
- (b) A certificate of inspection may be issued upon request by the contractor on record, provided all fees required by the construction code have been satisfied.

**Section 5-8-6. Special inspection.**

- (a) When application is made for a permit as described in article 4 of this chapter, the owner or person who is licensed in the State of Hawai'i as an architect or professional engineer who is acting as the owner's agent, shall employ one or more special inspectors to provide inspections during construction on the types of work listed under chapter 17 of the International Building Code. The special inspector shall be a qualified person who shall demonstrate competence, to the satisfaction of the authority having jurisdiction, to inspect the particular type of construction or operation requiring special inspection.
- (b) These inspections are required in addition to the inspections specified in sections 5-8-4 and 5-8-5 and shall be designated on the form provided by the authority having jurisdiction.

**Section 5-8-7. Regulatory inspection.**

The authority having jurisdiction may conduct regulatory inspections, upon request and after receipt of payment of the appropriate fee pursuant to article 7.

## **Division 2. Authorization for service; certificate of occupancy.**

### **Section 5-8-21. Permanent electrical service.**

Permanent electrical service shall be authorized by the authority having jurisdiction upon completion of the following requirements:

- (1) All permanent service equipment shall be inspected by the authority having jurisdiction;
- (2) For non-residential installations, all rooms containing permanent service equipment shall be completed and securable by means of a temporary or permanent door and lock system;
- (3) For residential installations, permanent service equipment shall be installed on permanent buildings, meter poles or meter pedestals with provisions for locking out the main service disconnects; and
- (4) The electrical contractor shall be responsible and in control of all permanent power access and usage.

### **Section 5-8-22. Certificate of occupancy.**

- (a) Certificate of occupancy requirement. No building or structure shall be used or occupied, and no change in the existing occupancy classification of a building or structure or portion thereof shall be made until the authority having jurisdiction has issued a certificate of occupancy therefor as provided herein. Issuance of a certificate of occupancy shall not be construed as an approval of a violation of the construction code or other applicable law.

Exception:

Group R, Division 3, and Group U occupancies will not be issued a certificate of occupancy.

- (b) Certificate issuance. If the authority having jurisdiction inspects the building or structure and finds that the work complies with the provisions of the construction code, the authority having jurisdiction shall issue a certificate of occupancy. The certificate of occupancy shall contain the following:
- (1) The permit number;
  - (2) The address of the structure;
  - (3) The name and address of the owner;
  - (4) A description of that portion of the structure for which the certificate is issued;
  - (5) A statement that the described portion of the structure has been inspected for compliance with the requirements of the construction code for the occupancy and division of occupancy and the use for which the proposed occupancy is classified;
  - (6) The name of the authority having jurisdiction;
  - (7) The edition of the code under which the permit was issued;
  - (8) The use and occupancy, in accordance with the provisions of chapter 3 of the International Building Code;

- (9) The type of construction as defined in chapter 6 of the International Building Code;
  - (10) The design occupant load(s);
  - (11) If an automatic sprinkler system is provided, whether the sprinkler system is required; and
  - (12) Any special stipulations and conditions of the permit.
- (c) Temporary certificate. Upon request by the applicant, the authority having jurisdiction may issue a temporary certificate of occupancy, that authorizes occupancy of a portion of the building or structure before the completion of all work covered by the permit. A temporary certificate of occupancy may be issued only if the designated portion or portions to be occupied may be occupied safely. The authority having jurisdiction shall set a time period during which the temporary certificate of occupancy is valid. An administrative fee of \$200 shall be applied per section 5-7-6.
- (d) Revocation. The authority having jurisdiction shall suspend or revoke a certificate of occupancy or completion issued pursuant to the construction code:
- (1) Wherever the certificate is issued either in error, or on the basis of incorrect information supplied, or both; or
  - (2) Where it is determined that the building or structure or portion thereof is in violation of the construction code or other applicable law.
- Such suspension or revocation shall be transmitted in writing.

## **Article 9. Unsafe Buildings or Structures.**

### **Section 5-9-1. Unsafe buildings or structures; public nuisances.**

Buildings or structures which are substandard, structurally unsafe, or are otherwise dangerous or hazardous to human life, or which in relation to existing use constitute a hazard to safety, health or public welfare by reason of inadequate maintenance, dilapidation to the state of falling into decay or partial ruin, fire hazard, insanitary condition, defective installation, abandonment where a vacant structure that is not secured against entry, or as specified in the construction code are unsafe buildings. All such unsafe buildings or structures are hereby declared to be public nuisances and shall be abated by repair, rehabilitation, demolition, removal, or other methods approved by the authority having jurisdiction in accordance with the procedure specified in this article.

### **Section 5-9-2. Substandard.**

Any building or portion thereof in which there exists any of the following listed conditions to an extent that it endangers the life, limb, health, property, safety or welfare of the public or the occupants thereof or violates applicable laws, rules, or standards, shall be

deemed and hereby is declared to be a substandard building. Conditions that are declared to be substandard include but are not limited to:

- (1) Lack of, or improper water closet, lavatory, bathtub or shower in a dwelling unit.
- (2) Lack of, or improper water closets, lavatories, and bathtubs or showers in R-1 Occupancies.
- (3) Lack of, or improper kitchen sink in a habitable building.
- (4) Lack of hot and cold water to basins, sinks, tubs and showers in R-1 Occupancies.
- (5) Lack of hot and cold water to basins, sinks, tubs and showers in a dwelling unit or efficiency living unit.
- (6) Lack of, or improper operation of required ventilating equipment.
- (7) Lack of minimum amounts of natural light and ventilation required by the construction code.
- (8) Room area or space dimensions less than the required minimum required by the construction code.
- (9) Lack of required lighting or ventilation.
- (10) Dampness of habitable rooms as determined by the department of health.
- (11) Infestations of insects, vermin, or rodents as determined by the department of health.
- (12) General dilapidation or improper maintenance.
- (13) Lack of connection to a required sewage disposal system.
- (14) Lack of adequate garbage and rubbish storage and removal facilities as determined by the department of health.

**Section 5-9-3. Structurally unsafe.**

Any building, structure, or portion thereof in which there exists any of the following listed conditions to an extent that it endangers the life, limb, health, property, safety or welfare of the public or the occupants thereof or violates applicable laws, rules, or standards, shall be deemed and hereby is declared to be a structurally unsafe building or structure.

Conditions that are declared to be structurally unsafe include but are not limited to:

- (1) Deteriorated or inadequate foundations.
- (2) Defective or deteriorating flooring or floor supports.
- (3) Flooring or floor supports of insufficient size to carry imposed loads with safety.
- (4) Members of walls, partitions, or other vertical supports that split, lean, or buckle due to defective material or deterioration.
- (5) Members of walls, partitions, or other vertical supports that are of insufficient size to carry imposed loads with safety.
- (6) Members of ceiling, roofs, ceiling and roof supports, or other horizontal members which sag, split, or buckle due to defective material or deterioration.
- (7) Members of ceilings, roofs, ceiling and roof supports, or other horizontal members that are of insufficient size to carry imposed loads safely.

- (8) Fireplaces or chimneys that separate, bulge, or settle due to defective material or deterioration.
- (9) Fireplaces or chimneys which are of insufficient size or strength to carry imposed loads with safety.

**Section 5-9-4. Dangerous or hazardous.**

Any building, structure, or portion thereof in which there exists any of the following listed conditions to an extent that it endangers the life, limb, health, property, safety or welfare of the public or the occupants thereof or violates applicable laws, rules, or standards, shall be deemed and hereby is declared to be a dangerous or hazardous building or structure. Conditions that fall within this category include but are not limited to:

- (1) Presence of a nuisance including:
  - (A) Any public nuisance known in common law or in equity jurisprudence.
  - (B) Any attractive nuisance which may prove detrimental to children whether in a building or on the premises of a building. This includes any unfenced man-made swimming pools, abandoned wells, shafts, or basements; any structurally unsound fences; and any debris or vegetation affecting the structural stability of structures.
  - (C) Whatever is dangerous to human life or is detrimental to health, as determined by the department of health.
  - (D) Exceeding the occupant load of a room by overcrowding a room with occupants.
  - (E) Insufficient lighting or ventilation.
  - (F) Inadequate or insanitary sewage or plumbing facilities.

“Insanitary” means a condition which is contrary to sanitary principles or is injurious to health. Conditions to which “insanitary” shall apply include, but are not limited to, the following:

    - (i) Any trap which does not maintain a proper trap seal.
    - (ii) Any opening in a drainage system, except where lawful, which is not provided with an approved water-sealed trap.
    - (iii) Any plumbing fixture or other waste discharging receptacle or device, which is not supplied with water sufficient to flush it and maintain it in a clean condition.
    - (iv) Any defective fixture, trap, pipe, or fitting.
    - (v) Any trap directly connected to a drainage system, the seal of which is not protected against siphonage and back-pressure by a vent pipe, unless otherwise allowed by the construction code.
    - (vi) Any connection, cross-connection, construction or condition, temporary or permanent, which would permit or make possible by any means whatsoever, for any unapproved foreign matter to enter a water distribution system used for domestic purposes.

- (vii) The foregoing enumeration of conditions to which the term “insanitary” shall apply, shall not preclude the application of that term to conditions that are, in fact, insanitary.
- (G) Uncleanliness, as determined by the department of health.
- (H) Whatever renders air, food, or drink unwholesome or detrimental to the health of human beings, as determined by the department of health.
- (2) Faulty weather protection, which shall include but not be limited to, the following:
  - (A) Deteriorating, crumbling, or loose plaster.
  - (B) Deteriorating or ineffective waterproofing of exterior walls, roof, foundations, or floors, including broken windows or doors.
  - (C) Defective or lack of weather protection for exterior wall covering, including lack of paint, weathering due to lack of paint or other approved protective covering.
  - (D) Broken, rotted, split or buckled exterior wall covering or roof coverings.
- (3) Inadequate maintenance. Any building or portion thereof which is determined to be an unsafe building in accordance with the construction code or other applicable laws or standards.
- (4) Inadequate exits. All buildings or portions thereof not provided with adequate exit facilities as required by chapter 5A, the building code, except those buildings or portions thereof whose exit facilities conformed with all applicable laws at the time of its construction and which have been adequately maintained. When an unsafe condition exists through lack of, or improper location of exits, additional exits may be required to be installed.
- (5) Any building or portion thereof that is not being occupied or used as intended or permitted.
- (6) Any electrical installation installed, altered, changed, or reconstructed contrary to the provisions of the construction code or other applicable law.
- (7) Any electrical installation, that complied with the existing laws, and standards in effect when the electrical work was performed, that is now found to be unsafe or dangerous to persons or property.

**Section 5-9-5. Inspection.**

The authority having jurisdiction shall inspect or cause to be inspected every building, structure, or portion thereof, including electrical and plumbing work, reported as or appearing to the authority having jurisdiction to be substandard, structurally unsafe, dangerous or hazardous.

**Section 5-9-6. Found to be unsafe; notice and order.**

- (a) If upon inspection, the building, structure, portion thereof, or installation is found to be unsafe as defined in this article, the authority having jurisdiction shall serve a written notice of violation stating the defects thereof and an accompanying order, upon the

parties responsible for the violation. At a minimum, the owner of the unsafe building, structure, portion thereof, or installation shall be deemed to be a responsible party. Additional responsible parties may include, but shall not be limited to any lessee or tenant of the building, structure, or portion thereof, and the owner of the property where the building, structure, or portion thereof, or installation is located. The notice and order shall be addressed to the responsible party and shall specify the date or time for compliance with such order.

- (b) Failure, neglect, or refusal to comply with any such notice and order shall be considered a violation of the construction code.
- (c) The notice and order may require the responsible party:
  - (1) To commence within forty-eight hours, either the required repairs or improvements to, or demolition and removal of the building, structure, or portions thereof. All such work shall be completed within ninety days from the date of notice, unless otherwise required by the authority having jurisdiction; or
  - (2) To vacate, or have vacated, the building, structure, or portion thereof immediately and not reoccupy it until the required repairs and improvements are completed, inspected, and approved by the authority having jurisdiction.
- (d) When an electrical installation is found to be unsafe or dangerous to persons or property, the defective installation shall be disconnected from the power source and tagged as unsafe to operate and the authority having jurisdiction may require other corrections as set forth in the order.
- (e) In the case of any gas piping or gas appliance, the authority having jurisdiction may order any person supplying gas to such piping or appliance, to discontinue supplying gas thereto, until such piping or appliance is made safe with respect to life, health, or property.
- (f) When any plumbing system is maintained in violation of the construction code and in violation of any notice and order issued pursuant to the provisions of this section, or where a nuisance exists in any building or on a site on which a building is situated, the authority having jurisdiction may institute an appropriate action or proceeding in any court of competent jurisdiction to prevent, restrain, correct, or abate the violation or nuisance.
- (g) Service of such notice of violation and order shall be by personal service, certified mail by posting a copy of the notice of violation and order at the site of the violation, or by publication. Service by publication shall be effected through publication once a week for two consecutive weeks, in a daily publication in the County pursuant to section 1-28.5, Hawai'i Revised Statutes.

**Section 5-9-7. Posting of signs.**

The authority having jurisdiction shall post at each entrance to buildings ordered vacated or at other visible locations on the property if access to the building is a hardship, a notice to read: "DO NOT ENTER. UNSAFE TO OCCUPY." Such notice shall remain posted until the required repairs, demolition, or removal are completed. Such notice shall not be removed without written permission of the authority having jurisdiction, and no person shall enter the building except for the purpose of making the required repairs or of demolishing the building.

In the event of a major natural disaster, the authority having jurisdiction may post "Restricted Use" or "Unsafe" placards at each entrance to a building or on the property if an inspection warrants such posting. Entry or occupancy in a building or portion of a building posted with a "Restricted Use" placard shall be limited to the restrictions stated on the placard. No entry is permitted in a building or portion of a building posted "Unsafe." Placards shall not be removed or altered unless authorized by the authority having jurisdiction.

**Section 5-9-8. Action upon noncompliance.**

Nothing contained herein shall be construed to limit or restrict the authority having jurisdiction from instituting, on behalf of the County, any other legal or equitable proceedings, in addition to those specified herein, to obtain compliance with the notice to repair, rehabilitate or to demolish and remove the building, structure, or portion thereof, or installation, and to recover the cost of such work from the owner or attach a lien to the property. The remedies provided in the construction code shall be cumulative and not exclusive.

**Article 10. Violations, Penalties, and Enforcement.**

**Section 5-10-1. Violations.**

It shall constitute a violation of the construction code for any person to cause or authorize the following to be done:

- (1) Violate any provision of the construction code or permit or variance issued pursuant to the construction code;
- (2) Erect, construct, enlarge, alter, repair, relocate, improve, remove, convert or demolish, equip, use, occupy, or maintain any building or structure, or cause or authorize the same to be done in violation of the construction code, including but not limited to chapter 5A, the building code;
- (3) Perform any electrical work or authorize the same to be done in violation of the construction code, including but not limited to chapter 5D, the electrical code;
- (4) Perform any plumbing work or authorize the same to be done in violation of the construction code, including but not limited to chapter 5F, the plumbing code; or

- (5) Perform any work covered by the construction code or authorize the same to be done in violation of the provisions of chapter 448E, Hawai'i Revised Statutes, relating to the licensing of electricians and plumbers.

**Section 5-10-2. Administrative enforcement.**

- (a) In lieu of, or in addition to other enforcement actions initiated pursuant to the construction code, whenever the authority having jurisdiction determines that any person has violated or is violating this code or any permit or variance issued pursuant to this code, the authority having jurisdiction shall serve a written notice of violation and order upon the parties responsible for the violation. At a minimum, the owner of the property where the violation is located shall be deemed to be a responsible party. Additional responsible parties may include, but shall not be limited to, any lessee or tenant, or both, of the property where the violation is located.
- (b) The notice of violation shall include at a minimum, the following information:
  - (1) Date of the notice;
  - (2) Name and address of the party noticed;
  - (3) Section number or citation of the law, standard, permit, or variance that was violated;
  - (4) Nature of the violation;
  - (5) Location, date, and time of the violation; and
  - (6) The deadline to correct the violation or provide the authority having jurisdiction with periodic progress reports detailing corrective measures taken to correct the violation by specified deadlines.
- (c) The order may require the party responsible for the violation to do any or all of the following:
  - (1) Cease and desist from the violation, including but not limited to, immediately stopping all work whether for failure to obtain a required permit or for violation of the requirements of any permit or variance issued pursuant to the construction code;
  - (2) Correct the violation, at the party's own expense, before a date specified in the order;
  - (3) Provide the authority having jurisdiction with periodic progress reports detailing corrective measures taken to correct the violation by specified deadlines;
  - (4) Pay a civil fine not to exceed \$1,000 in the manner, at the place and before the date specified in the order; or
  - (5) Pay a civil fine not to exceed \$1,000 per day for each day in which the violation persists, in the manner and at the time and place specified in the order.
- (d) The order shall advise the party responsible for the violation that:
  - (1) The order shall become final thirty days after the date of delivery; and

- (2) The order may be appealed to the board of appeals, which must receive the appeal in writing on or before the date the order becomes final. An appeal to the board of appeals shall not stay any provision of the order.
- (e) Effect of order; right to appeal.
- (1) The order is effective upon delivery and the party responsible for the violation is required to comply with the order from the date that they receive notice of the order.
  - (2) The order shall become final thirty days after the date of delivery. The order may be appealed to the board of appeals. An appeal of the order must be received in writing by the board of appeals on or before the date the order becomes final. An appeal to the board of appeals shall not stay any provision of the order.
- (f) Service.  
The party responsible for the violation shall be served with the notice of violation and order. Service shall be by personal service, certified mail, by posting a copy of the notice of violation and order at the site of the violation, or by publication. Service by publication shall be effected through publication once a week for two consecutive weeks, in a daily publication in the County pursuant to section 1-28.5, Hawai'i Revised Statutes.
- (g) Judicial enforcement of order.  
The authority having jurisdiction may institute a civil action in any court of competent jurisdiction for the enforcement of any final order issued pursuant to this article. Where the civil action has been instituted to enforce the civil fine, recover County costs, or both, as imposed by such final order, the authority having jurisdiction need only show that:
- (1) The notice of violation and order were served;
  - (2) A civil fine, County costs, or both were imposed;
  - (3) The amount of the civil fine, County costs, or both that were imposed; and
  - (4) The fine, County costs, or both have not been paid.

**Section 5-10-3. Criminal prosecution.**

- (a) In case the parties responsible for violating any provisions of the construction code fail, neglect, or refuse to comply or correct a violation, the authority having jurisdiction may submit the matter to the proper authority for penal enforcement.
- (b) Any person violating any of the provisions of the construction code shall, upon conviction, be deemed guilty of a petty misdemeanor. Further, each person so convicted shall be deemed guilty of a separate offense for each and every day or portion thereof during which any violation of the provisions of the construction code is committed, continued, or permitted. Upon conviction of any violation, such person

shall be punishable by a fine of not more than \$1,000, or by imprisonment for not more than thirty days, or by both fine and imprisonment.

- (c) Procedure on arrest.  
Any authorized personnel designated by the authority having jurisdiction, who has been deputized by the chief of police as a special officer for the purpose of enforcing the provisions of the construction code, may arrest without warrant alleged violators by issuing a summons or citation in accordance with section 803-6, Hawai'i Revised Statutes, and the procedure specified in this section. Nothing in this section shall be construed as barring the initiation of prosecution by warrant or such other judicial process as permitted by statute or rule of court.
- (d) Upon making an arrest for a violation of the construction code, any authorized personnel designated by the authority having jurisdiction may take the name and address of the alleged violator and shall issue to the alleged violator in writing a summons or citation. The summons or citation shall notify the alleged violator to answer the complaint to be entered against the alleged violator at a place and at a time provided in the summons or citation.
- (e) Summons or citation.
  - (1) There shall be provided for use by authorized personnel a form of summons or citation for use in citing alleged violators of the construction code that does not mandate the physical arrest of such alleged violators. The form and content of such summons or citation shall be as adopted or prescribed by the administrative judge of the district court and shall be printed on a form commensurate with the form of other summonses or citations used in modern methods of arrest, so designed to include all necessary information to make the same valid within the applicable laws of the State of Hawai'i and the County of Hawai'i.
  - (2) In every case when a citation is issued, the original of the same shall be given to the alleged violator, provided that the administrative judge of the district court may prescribe the giving to the alleged violator of a copy of the citation and provide for the disposition of the original and any other copies.
  - (3) Every citation shall be consecutively numbered and each copy shall bear the number of its respective original.
- (f) The provisions of this section are in addition to any other applicable remedy or penalty provided by law.

**Section 5-10-4. Injunctive action.**

The authority having jurisdiction may maintain an action for an injunction to restrain or remedy any violation of the provisions of the construction code and may take any other lawful action to prevent or remedy any violation.

**Section 5-10-5. Remedies cumulative.**

The remedies provided in the construction code shall be cumulative and not exclusive.

**Article 11. Variances and Appeals.**

**Section 5-11-1. Variances.**

Whenever strict application of any provision of the construction code, except for the provisions relating to materials, methods of construction, equipment, fixtures, devices, or appliances, would result in practical difficulty or unnecessary hardship that would deprive the owner of the reasonable use of the land or building involved, the owner may petition the board of appeals for a variance from the provision. In granting a variance, the board of appeals shall prescribe any conditions that it deems to be necessary or desirable. No variance from the strict application of the construction code shall be granted by the board of appeals unless it finds all of the following:

- (1) That there are special circumstances or conditions applying to the land or building for which the variance is sought, which circumstances or conditions are peculiar to such land or building and do not apply generally to lands or buildings in the neighborhood or surrounding property, and that the circumstances or conditions are such that the strict application of the provisions of the construction code would deprive the applicant of the reasonable use of the land or building;
- (2) That the granting of the variance is necessary for the reasonable use of the land or building and that the variance granted is the minimum variance that will accomplish this purpose; and
- (3) That the granting of the variance will be consistent with the intent and purpose of the construction code, will not be injurious to persons or property, will not create additional fire hazards, and will not be detrimental to the public welfare. In making its determination, the board of appeals shall take into account the character, use and type of occupancy and construction of adjoining buildings, buildings on adjoining lots, and the building or land involved.

**Section 5-11-2. Appeals regarding alternative materials, design, and methods of construction.**

Any person denied the use of new or alternative materials, design, methods of construction, equipment, fixtures, devices, or appliances by the authority having jurisdiction may, within thirty days after the authority having jurisdiction's decision, appeal the decision to the board of appeals. In considering an appeal, the board may require any reasonable test of the proposed material, design, method of construction, equipment, fixture, device, or

appliance, and the appellant shall pay all expenses necessary for the test. The board of appeals may reverse the authority having jurisdiction's decision if it finds:

- (1) That the new or alternative material, design, method of construction, equipment, fixture, device, or appliance meets standards established by the construction code;
- (2) That permitting the requested use will not jeopardize the safety of persons or property; and
- (3) That the requested use will not be contrary to the intent and purpose of the construction code.

**Section 5-11-3. Other appeals.**

Any person aggrieved by the decision of the authority having jurisdiction in the administration or application of the construction code, other than that prescribed in sections 5-11-1 and 5-11-2, may, within thirty days after the date of the authority having jurisdiction's decision, appeal the decision to the board of appeals. The board of appeals may affirm the decision of the authority having jurisdiction, or it may reverse or modify the decision if the decision is:

- (1) In violation of the construction code or other applicable law;
- (2) Clearly erroneous in view of the reliable, probative, and substantial evidence on the whole record; or
- (3) Arbitrary, or capricious, or characterized by an abuse of discretion or clearly unwarranted exercise of discretion.

**Section 5-11-4. Rules; Adoption by the board of appeals.**

The board of appeals shall adopt rules pursuant to chapter 91, Hawai'i Revised Statutes, necessary for the purposes of this article."

**SECTION 3.** The Hawai‘i County Code 1983 (2016 Edition, as amended) is amended by adding a new chapter, relating to the building code, to be designated chapter 5A, and to read as follows:

**“CHAPTER 5A. BUILDING CODE.**

**Article 1. General Provisions.**

**Section 5A-1-1. Title.**

This chapter shall be known as the “building code.”

**Section 5A-1-2. Purpose.**

The purpose of this chapter is to provide minimum standards to safeguard life or limb, health, property and public welfare by regulating and controlling the design, construction, quality of materials, use and occupancy, location and maintenance of all buildings and structures within the County and certain equipment specifically regulated herein.

**Section 5A-1-3. Scope; exceptions.**

This chapter shall apply to the design, construction, alteration, relocation, enlargement, replacement, repair, equipment, use and occupancy, location, maintenance, removal and demolition of every building or structure or any appurtenances connected or attached to such buildings or structures within the County inland of the shoreline high-water line. Exceptions to these minimum requirements are listed below:

This chapter shall not apply to:

- (1) Work or installations not covered by the International Building Code, 2006 Edition, as adopted and amended by the State Building Code, chapter 180, title 3 Hawai‘i Administrative Rules;
- (2) Work on buildings or premises owned by or under the direct control of the Federal government;
- (3) Work in public State or County road right-of-ways for utility installations, street lighting, traffic signals, police and fire alarms, bridges, poles, hydraulic flood control structures, and mechanical equipment not specifically regulated in this code where installed:
  - (A) Outside the proposed premises or boundary lines in a subdivision under development; or
  - (B) In an approved subdivision, where the work is in planned or actual roadways or other common infrastructure areas; or
- (4) Pursuant to section 448E-13, Hawai‘i Revised Statutes, work by employees of a public utility within the State under a franchise or charter granted by the State which is regulated by the public utilities commission and community antennae television company, while so employed;

- (5) Agricultural buildings, structures, and appurtenances without electrical power and plumbing systems are exempt from permit and construction code requirements, pursuant to section 46-88, Hawai'i Revised Statutes, except as otherwise provided for in this construction code. No electrical power shall be connected to a building or structure without first obtaining a permit for the electrical work.

**Section 5A-1-4. Administrative provisions.**

Provisions relating to permitting, enforcement, inspection, and other administrative procedures pertaining to this chapter are contained in chapter 5, the construction administrative code.

**Section 5A-1-5. Existing buildings.**

- (a) Permitted buildings in existence at the time of the adoption of this chapter may have their existing permitted use or occupancy continued if such use or occupancy was legal at the time of the adoption of this chapter, provided such continued use does not constitute a hazard to the general safety and welfare of the occupants and the public.
- (b) Alteration, repair, addition, and change of occupancy. Alteration, repair, addition, and change of occupancy to a building or structure in existence at the time of the adoption of this chapter shall comply with the requirements of chapter 34 of the International Building Code, relating to existing structures, until the adoption by the County of the International Existing Building Code.

**Section 5A-1-6. Definitions.**

As used in this chapter, unless it is apparent from the context that a different meaning is intended:

**“Accessory structure”** means a structure not greater than 3,000 square feet (279 m<sup>2</sup>) in floor area, and not over two stories in height, the use of which is customarily accessory to and incidental to that of the dwelling and which is located on the same lot.

**“Agricultural building”** means a development, including a nonresidential building or structure, built for agricultural or aquacultural purposes, located on a commercial farm or ranch constructed or installed to house farm or ranch implements, agricultural or aquacultural feeds or supplies, livestock, poultry, or other agricultural or aquacultural products, used in or necessary for the operation of the farm or ranch, or for the processing and selling of farm or ranch products. An agricultural building for personal use shall be excluded from this definition.

**“Authority having jurisdiction”** means the director of the department of public works, or the director's authorized representative.

**“Building work”** means the design, construction, alteration, relocation, enlargement, replacement, repair, removal, demolition of any building or structure, or any other activities regulated by this chapter.

**“Chapter”** means this chapter.

**“This code”** means the building code, contained in chapter 5A, or the construction administrative code, contained in chapter 5, or both, as the context requires.

**“Construction code”** means collectively: chapter 5, the construction administrative code; chapter 5A, the building code; chapter 5D, the electrical code; chapter 5E, the energy conservation code; chapter 5F, the plumbing code; and all administrative rules adopted pursuant to these chapters.

**“Dwelling”** means any building that contains one or two dwelling units used, intended, or designed to be built, used, rented, leased, let or hired out to be occupied, or that are occupied for living purposes.

**“IBC”** means the ICC, International Building Code, 2006 Edition, as copyrighted by the International Code Council, Inc., 4051 West Flossmoor Road, Country Club Hills, IL, 60478-5795.

**“ICC”** means the International Code Council.

**“Owner-builder”** means owners or lessees of property who build or improve buildings or structures on their property for their own use, or for use by their immediate family. This definition shall not preempt owner-builder by exemption as defined by section 444-2.5, Hawai‘i Revised Statutes.

**“Permit”** means a formal authorization issued by the authority having jurisdiction that authorizes performance of specified work, pursuant to the construction code, including the following chapters and all administrative rules adopted pursuant to these chapters:

- (1) 5, the construction administrative code;
- (2) 5A, the building code;
- (3) 5D, the electrical code;
- (4) 5E, the energy conservation code; and
- (5) 5F, the plumbing code.

**“Person”** means any individual, firm, partnership, association, or corporation; or its or their successors or assigns, according to the context thereof.

**“Section”** means a section of a chapter of the International Building Code.

**“Table”** means a table in this chapter.

**Section 5A-1-7. Compliance required.**

- (a) No person shall perform or cause to be performed any building work which does not comply with the provisions of this code or any permit issued pursuant to this code.
- (b) No person shall perform any work covered by this code in violation of the provisions of chapters 444 or 448E, Hawai‘i Revised Statutes.
- (c) Any approval or permit issued pursuant to the provisions of this code shall comply with all applicable requirements of this code.
- (d) The granting of a permit, variance, or approval of plans or specifications pursuant to this code does not dispense with the necessity to comply with any applicable law to which a permit holder may also be subject.

**Section 5A-1-8. Conflict.**

- (a) If any provisions of this code conflict with or contravene provisions of the Hawai‘i State Building Code or the International Building Code that have been incorporated by reference, the provisions of this code shall prevail as to all matters and questions arising out of the subject matter of such provisions.
- (b) In situations where two or more provisions of this code and any applicable law, other than those provided for in subsection (a), cover the same subject matter, the stricter shall be complied with.

**Section 5A-1-9. References to model codes.**

- (1) Wherever referenced in this code, the ICC Electrical Code shall mean the electrical Code, chapter 5D, Hawai‘i County Code.
- (2) Wherever in this Code reference is made to the International Fuel Gas Code, the provisions of the International Fuel Gas Code shall be deemed to be only guidelines and not mandatory.
- (3) Wherever in this Code reference is made to the International Mechanical Code, the provisions of the International Mechanical Code shall be deemed to be only guidelines and not mandatory.
- (4) Wherever referenced in this code, the International Plumbing Code shall mean the plumbing code, chapter 5F, Hawai‘i County Code.
- (5) Wherever in this Code reference is made to the International Property Maintenance Code, the provisions of the International Property Maintenance Code shall be deemed to be only guidelines and not mandatory.

- (6) Wherever referenced in this code, the International Fire Code shall mean the fire code, chapter 26, Hawai'i County Code.
- (7) Wherever referenced in this code, the International Energy Conservation Code, shall mean the energy conservation code, chapter 5E, Hawai'i County Code.

**Article 2. Installation Requirements.**

**Section 5A-2-1. International building code adopted.**

- (a) The International Building Code, 2006 Edition as published by the International Code Council, Incorporated, 4051 West Flossmoor Road, Country Club Hills, IL 60478, including appendices, is incorporated by reference and made a part of this code, subject to any amendments hereinafter set forth in this chapter.
- (b) The scope, technical specifications, and exemptions set forth in the International Building Code, 2006 Edition, are hereby adopted as the standard for building work covered by this code, provided there are no specific provisions in any other section of this code covering the particular matter.
- (c) A copy of the International Building Code, 2006 Edition, shall be available for public inspection at the Hilo and Kailua-Kona offices of the department of public works and at the office of the County clerk.
- (d) The International Building Code, 2006 Edition, adopted and incorporated by reference into this code, shall be subject to the amendments hereinafter set forth.
  - (1) Chapter 1, "Administration," of the International Building Code is deleted in its entirety.
  - (2) Section 202 of the International Building Code is amended by adding the following definitions:

"BUILDING. A building is any structure used or intended for supporting any use or occupancy. The term shall include but not be limited to any structure mounted on wheels such as a trailer, wagon or vehicle which is parked and stationary for any 24-hour period, and is used for business or living purposes; provided, however, that the term shall not include a push cart or push wagon which is readily movable and which does not exceed 25 square feet in area, nor shall the term include a trailer or vehicle, used exclusively for the purpose of selling any commercial product therefrom, which hold a vehicle license and actually travels on public or private streets.

BUILDING OFFICIAL is the director of the County department of public works or the director's authorized deputy.

CARPOR is a private garage which is at least 100 percent open on one side and with 50 percent net openings on another side or which is provided with an equivalent of such openings on two or more sides.

A private garage which is 100 percent open on one side and 25 percent open on another side with the latter opening so located to provide adequate cross ventilation may be considered a carport when approved by the building official.

EXISTING BUILDING is a building for which a legal building permit has been issued, or one which complied with this Code in effect at the time the building was erected.

FAMILY shall be as defined in the Zoning Code except that a nursing, care home, or other similar facility with not more than five patients may be considered a family under this code.

FIRE CODE. The State Fire Code as adopted by the State Fire Council."

- (3) Section 308.2 of the International Building Code is amended to read as follows:

**"308.2 Group I-1.** This occupancy shall include buildings, structures or parts thereof housing more than 16 persons, on a 24-hour basis, who because of age, mental disability or other reasons, live in a supervised residential environment that provides personal care services in an assisted living facility.

The residents participate in fire drills, are self starting, and may require some physical assistance from up to one staff to reach a point of safety in an emergency situation. Facilities with residents who require assistance by more than one staff member, are not self starting, who are bedridden beyond 14 days, or require intermittent nursing care beyond 45 days, shall reside on the first floor in all Type III, IV, and V construction, or shall be classified as Group I-2.

A facility such as the above with five or fewer persons shall be classified as a Group R-3 or shall comply with the International Residential Code in accordance with Section 101.2. A facility such as above, housing at least six and not more than 16 persons, shall be classified as Group R-4."

- (4) Section 308.3 of the International Building Code is amended to read as follows:

**“308.3 Group I-2.** This occupancy shall include buildings and structures used for personal, medical, surgical, psychiatric, nursing or custodial care on a 24-hour basis of more than five persons who are not capable of self-preservation. This group shall include, but not be limited to, the following:

Hospitals

Nursing homes (both intermediate-care facilities and skilled nursing facilities)

Mental hospitals

Detoxification facilities

Specialized Alzheimer’s Facilities or areas

Assisted Living Facilities (with residents beyond group I-1 limitations for capability)

A facility such as the above with five or fewer persons shall be classified as Group R-3 or shall comply with the International Residential Code in accordance with Section 101.2.”

- (5) Section 310.1 of the International Building Code is amended to read as follows:

**“310.1 Residential Group R.** Residential Group R includes, among others, the use of a building or structure, or a portion thereof, for sleeping purposes when not classified as an Institutional Group I or when not regulated by the International Residential Code in accordance with Section 101.2. Residential occupancies shall include the following:

**R-1** Residential occupancies where the occupants are primarily transient in nature, including:

Boarding houses (transient)

Hotels (transient)

Motels (transient)

**R-2** Residential occupancies containing sleeping units or more than two dwelling units where the occupants are primarily permanent in nature, and facilities providing personal care services that have residents that are capable of self evacuation in an emergency situation, including:

Apartment houses

Boarding houses (not transient)

Convents

Dormitories

Facilities providing personal care services (with residents that are capable of self evacuation)  
Fraternities and sororities  
Hotels (nontransient)  
Monasteries  
Motels (nontransient)  
Vacation timeshare properties

Facilities providing personal care services with 16 or fewer occupants are permitted to comply with the construction requirements for Group R-3.

**R-3** Residential occupancies where the occupants are primarily permanent in nature and not classified as Group R-1, R-2, R-4 or I including:

Buildings that do not contain more than two dwelling units.  
Adult facilities that provide accommodations for five or fewer persons of any age for less than 24 hours.  
Child care facilities that provide accommodations for five or fewer persons of any age for less than 24 hours.  
Congregate living facilities with 16 or fewer persons.

Adult and child care facilities that are within a single-family home are permitted to comply with the International Residential Code in accordance with Section 101.2.

**R-4** Residential occupancies shall include buildings arranged for occupancy as assisted living facilities including more than five but not more than 16 occupants, excluding staff. Residents shall meet the ability to evacuate requirements and other limitations as required in Group I-1.

Group R-4 occupancies shall meet the requirements for construction as defined for Group R-3, except as otherwise provided for in this code, or shall comply with the International Residential Code.”

- (6) The definition of “Personal Care Service” in Section 310.2 of the International Building Code is amended to read as follows:

“PERSONAL CARE SERVICE. The care of residents who do not require chronic or convalescent, health, medical or nursing care. Personal care involves responsibility for the safety of the resident while inside the building. The types of facilities providing personal care services shall include, but not be limited to, the following: assisted living facilities, residential care

facilities, halfway houses, group homes, congregate care facilities, social rehabilitation facilities, alcohol and drug abuse centers and convalescent facilities.”

- (7) The definition of “Residential Care/Assisted Living Facilities” in Section 310.2 of the International Building Code is amended to read as follows:

“ASSISTED LIVING FACILITIES. A building or part thereof housing persons, on a 24-hour basis, who because of age, mental disability or other reasons, live in a supervised residential environment which provides personal care services and are licensed by the State.”

- (8) Section 310.3 of the International Building Code is added as an interim provision until the International Residential Codes are adopted, to read as follows:

**310.3.1 Dwellings and Lodging Houses.** Congregate residences (each accommodating 10 persons or less).

**310.3.2 Construction, Height and Allowable Area.** Buildings or parts of building classed Group R because of the use or character of the occupancy shall be limited to the types of construction set forth in Table 503 and shall not exceed allowable height as allowed by the IBC.

**310.3.3 Location on Property.** For fire-resistive protection of exterior walls and openings, as determined by location on property, see Section 503, Section 601, Section 704, Section 705 and Section 715 of the IBC.

**310.3.4 Access and Exit Facilities and Emergency Escapes.** Exits shall be provided as specified in Chapter 10.

Access to, and egress from, buildings required to be accessible shall be provided as specified in Chapter 11.

Basements in dwelling units and every sleeping room below the fourth story shall have at least one operable window or door approved for emergency escape or rescue which shall open directly into a public street, public alley, yard or exit court. The units shall be operable from the inside to provide a full clear opening without the use of separate tools.

All escape or rescue windows shall have a minimum net clear openable area of 5.7 square feet. The minimum net clear openable height dimension shall be 24 inches. The minimum net clear openable width dimension shall be 20 inches. When windows are provided as a means of escape or rescue they shall

have a finished sill height of not more than 44 inches above the floor.

Bars, grilles, grates or similar devices may be installed on emergency escape or rescue windows or doors, provided:

- (1) The devices are equipped with approved released mechanisms which are openable from the inside without the use of a key or special knowledge or effort; and
- (2) The building is equipped with smoke detectors installed in accordance with Section 310.3.10.

**Exceptions:**

- (1) Glass jalousie blade windows and fixed glass may be used for emergency escape or rescue.
- (2) Escape or rescue windows in Group R, Division 1 Occupancies opening into an exterior exit balcony serving more than two dwelling units or hotel guest rooms shall have a finished sill height not more than 68 inches above the floor.

**310.3.5 Light, Ventilation and Sanitation.**

(a) **General.** For the purpose of determining the light or ventilation required by this section, any room may be considered as a portion of an adjoining room when half of the area of the common wall is open and unobstructed and provides an opening of not less than one tenth of the floor area of the interior room or 25 square feet, whichever is greater.

Exterior openings for natural light or ventilation required by this section shall open directly onto a public way or a yard or court located on the same lot as the building.

**Exceptions:**

- (1) Required windows may open into a roofed porch where the porch:
  - (A) Abuts a public way, yard or court; and
  - (B) Has a ceiling height of not less than 7 feet; and
  - (C) Has a longer side at least 65 percent open and unobstructed.
- (2) Skylights.

(b) **Light.** Guest rooms and habitable rooms within a dwelling unit or congregate residence shall be provided with natural light by means of exterior glazed opening with an area not less than

one tenth of the floor area of such rooms with a minimum of 5 square feet.

(c) **Ventilation.** Guest rooms and habitable rooms within a dwelling unit or congregate residence shall be provided with natural ventilation by means of an openable exterior opening with an area of not less than one twentieth of the floor area of such rooms with a minimum of 5 square feet.

In lieu of required exterior opening for natural ventilation, a mechanical ventilating system may be provided. Such system shall be capable of providing two air changes per hour in all guest rooms, dormitories, habitable rooms and in public corridors. One fifth of the air supply shall be taken from the outside.

Bathrooms, water closet compartments, laundry rooms and similar rooms shall be provided with natural ventilation by means of openable exterior openings with an area not less than one twentieth of the floor area of such rooms with a minimum of 1½ square feet.

In lieu of required exterior openings for natural ventilation in bathrooms containing a bathtub or shower or combination thereof, laundry rooms and similar rooms, a mechanical ventilation system connected directly to the outside capable of providing five air changes per hour shall be provided. The point of discharge of exhaust air shall be at least 3 feet from any opening into the building. Bathrooms which contain only a water closet or lavatory or combination thereof, and similar rooms may be ventilated with an approved mechanical recirculating fan or similar device designed to remove odors from the air.

(d) **Sanitation.** Every building shall be provided with at least one water closet. Hotels or subdivisions thereof where both sexes are accommodated shall contain at least two separate toilet facilities which are conspicuously identified for male or female use, each of which contains at least one water closet. The water closet stool shall be located in a clear space not less than 30 inches in width. The clear space in front of the water closet stool shall not be less than 24 inches.

Dwellings shall be provided with a kitchen equipped with a kitchen sink. Dwelling units, congregate residences and lodging houses shall be provided with a bathroom equipped with

facilities consisting of a water closet, lavatory and either a bathtub or shower. Each sink, lavatory and either a bathtub or shower shall be equipped with hot and cold running water necessary for its normal operation.

No dwelling or dwelling unit containing two or more guests rooms shall have room arrangements such that access to a bathroom or water closet compartment intended for use by occupants of more than one sleeping room can be had only by going through another sleeping room, nor shall room arrangements be such that access to a sleeping room can be had only by going through another sleeping room or a bathroom or water closet compartment.

### **310.3.6 Yards and Courts.**

(a) **Scope.** This section shall apply to yards and courts having required windows opening therein.

(b) **Yards.** Yards shall not be less than 3 feet in width for one-story and two-story buildings. For buildings more than two stories in height, the minimum width of the yard shall be increased at the rate of 1 foot for each additional story. For buildings exceeding 14 stories in height, the required width of the yard shall be computed on the basis of 14 stories.

(c) **Courts shall not be less than 3 feet in width.** Courts having windows opening on opposite sides shall not be less than 6 feet in width. Courts bounded on three or more sides by the walls of the building shall not be less than 10 feet in length unless bounded on one end by a public way or yard. For buildings more than two stories in height, the court shall be increased 1 foot in width and 2 feet in length for each additional story. For buildings exceeding 14 stories in height, the required dimensions shall be computed on the basis of 14 stories.

Adequate access shall be provided to the bottom of all courts for cleaning purposes. Every court more than two stories in height shall be provided with a horizontal air intake at the bottom not less than 10 square feet in area and leading to the exterior of the building unless abutting a yard or public way. The construction of the air intake shall be as required for the court walls of the building, but in no case shall be less than one-hour fire resistive.

### **310.3.7 Room dimensions.**

(a) **Ceiling Heights.** Habitable space shall have a ceiling height of not less than 7 feet 6 inches except as otherwise permitted in this section. Kitchens, halls, bathrooms and toilet compartments may have a ceiling height of not less than 7 feet measured to the lowest projection from the ceiling. Where exposed beam ceiling members are spaced at less than 48 inches on center, ceiling height shall be measured to the bottom of these members. Where exposed beam ceiling members are spaced at 48 inches or more on center, ceiling height shall be measured to the bottom of the deck supported by these members, provided that the bottom of the members is not less than 7 feet above the floor.

If any room in a building has a sloping ceiling, the prescribed ceiling height for the room is required in only one half the area thereof. No portion of the room measuring less than 5 feet from the finished floor to the finished ceiling shall be included in any computation of the minimum area thereof.

If any room has a furred ceiling, the prescribed ceiling height is required in two thirds the area thereof, but in no case shall the height of the furred ceiling be less than 7 feet.

(b) **Floor Area.** Dwelling units and congregate residences shall have at least one room which shall have not less than 120 square feet of floor area. Other habitable rooms except kitchens shall have an area of not less than 70 square feet. Efficiency dwelling units shall comply with the requirements of Section 310.3.8.

(c) **Width.** Habitable rooms other than kitchen shall not be less than 7 feet in any dimension.

### **310.3.8 Efficiency Dwellings Units.**

An efficiency dwelling unit shall conform to the requirements of the code except as herein provided:

- (1) The unit shall have a living room of not less than 220 square feet of superficial floor area. An additional 100 square feet of superficial floor area shall be provided for each occupant of such unit in excess of two.
- (2) The unit shall be provided with a separate closet.
- (3) The unit shall be provided with a kitchen sink, cooking appliance and refrigeration facilities, each having a

clear working space of not less than 30 inches in front. Light and ventilation conforming to this code shall be provided.

- (4) The unit shall be provided with a separate bathroom containing a water closet, lavatory and bathtub or shower.

### **310.3.9 Shaft and Exit Enclosures.**

Exits shall be enclosed as specified in Section 1020. Elevator shafts, vent shafts, dumbwaiter shafts, clothes chutes and other vertical openings shall be enclosed and the enclosure shall be as specified in Section 707.

### **310.3.10 Smoke Detectors.**

(a) **General.** Dwelling units, congregate residences and hotel or lodging house guest rooms that are used for sleeping purposes shall be provided with smoke detectors. Detectors shall be installed in accordance with the approved manufacturer's instructions.

(b) **Additions, alterations or repairs to Group R Occupancies.** When the valuation of an addition, alteration or repair to a Group "R Occupancy sleeping room exceeds \$1,000 and a permit is required, or when one or more sleeping rooms are added or created in existing Group R Occupancies, smoke detectors shall be installed in accordance with subsections (c), (d), and (e) of this section.

(c) **Power Source.** In new construction, required smoke detectors shall receive their primary power from the building wiring when such wiring is served from a commercial source and shall be equipped with a battery backup. The detector shall emit a signal when the batteries are low. Wiring shall be permanent and without a disconnecting switch other than those required for overcurrent protection. Smoke detectors may be solely battery operated when installed in existing buildings; or in buildings without commercial power; or in buildings which undergo alterations, repairs or additions regulated by subsection (b) of this section.

(d) **Location within dwelling units.** In dwelling units, a detector shall be installed in each sleeping room and at a point centrally located in the corridor or area giving access to each separate sleeping area. When the dwelling unit has more than

one story and in dwellings with basements, a detector shall be installed on each story and in the basement. In dwelling units where a story or basement split into two or more levels, the smoke detector shall be installed on the upper level, except that when the lower level contains a sleeping area, a detector shall be installed on each level. When sleeping rooms are on an upper level, the detector shall be placed at the ceiling of the upper level in close proximity to the stairway. In dwellings units where the ceiling height of a room open to the hallway serving the bedrooms exceeds that of the hallway by 24 inches or more, smoke detectors shall be installed in the hallway and in the adjacent room. Detectors shall sound an alarm audible in all sleeping areas of the dwelling unit in which they are located.

**(e) Location in efficiency dwelling units, congregate residences and hotels.** In efficiency dwelling units, hotel suites and in hotel and congregate residences sleeping rooms, detectors shall be located on the ceiling or wall of the main room or each sleeping room. When sleeping rooms within an efficiency dwelling unit or hotel suite are on an upper level, the detector shall be placed at the ceiling of the upper level in close proximity to the stairway. When actuated, the detector shall sound an alarm audible within the sleeping area of the dwelling unit, hotel suite or sleeping room in which it is located.

**310.3.11 Fire Alarm Systems.** Fire alarm systems shall comply with the Fire Code and be approved by the fire chief.

**310.3.12 Cooking Unit Clearance.**

**(a) Minimum Vertical Clearance.** There shall be a minimum vertical clearance of not less than 30 inches between the cooking top of domestic oil, gas, and electric ranges and the underside of unprotected combustible material above such ranges. When the underside of such combustible material is protected with insulated millboard of at least ¼ inch thick covered with sheet metal of not less than 0.021 inch thick (No 28 U.S. gauge) or a metal ventilating hood, the distance shall be not less than 24 inches.

**(b) Minimum Horizontal Clearance.** The minimum horizontal clearance from edge of the burner head(s) of top (or surface) cooking unit to combustible walls extending above the cooking surface shall be not less than 12 inches.

**Exception:** Walls of combustible materials to be installed within 12 inches of a cooking unit shall be provided with protection equivalent to ½-inch gypsum wallboard covered with laminated plastic. The height of the laminated plastic shall be 12 inch minimum.

(c) **Alternate Materials.** Where alternate materials other than as specified in subsections (a) and (b) are used as approved by the building official, the surface of such material shall have a smooth nonabsorbent finish.”

- (9) Section 403.8 of the International Building Code is amended to read as follows:

**“403.8 Fire command station.** Fire command stations shall comply with the Fire Code and be approved by the fire chief.”

- (10) Section 419.4 of the International Building Code is added to read as follows:

**“419.4 Group I-1 Assisted Living Facilities.** Group I-1 Assisted Living Facilities shall comply with the provisions of Sections 419.4.1 and 419.4.2.

**419.4.1 Building Story Limitations.** Buildings shall not exceed one story in Type VB construction, two stories in Types IIB, III, IV, and VA construction, and three stories in Type IIA construction, including any allowable automatic sprinkler increases. Other construction type limitations on stories shall be limited by the provisions of Chapter 5.

**4.19.4.2 Group I-1 Smoke Barriers.** Group I-1 occupancies shall be provided with at least one smoke barrier in accordance with Section 709. Smoke barriers shall subdivide every story used by residents for sleeping or treatment into at least two smoke compartments. Each compartment shall have not more than 16 sleeping rooms, and the travel distance from any point in a smoke compartment to a smoke barrier door shall not exceed 150 feet (45,720 mm). At least 10 square feet (0.93 m<sup>2</sup>) of refuge area per resident shall be provided within the aggregate area of corridors, treatment rooms, or other low hazard common space rooms on each side of each smoke barrier.”

- (11) Section 903.2.5 of the International Building Code is amended to read as follows:

**“903.2.5 Group I.** An automatic sprinkler system shall be provided throughout buildings with Group I fire area.”

(12) Section 903.2.7 of the International Building Code is amended to read as follows:

**“903.2.7 Group R.** An automatic sprinkler system installed in accordance with Section 903.3 shall be provided throughout all buildings with a Group R fire area.

**Exception:** R-3 residential occupancies.”

(13) Section 911.1 of the International Building Code is amended to read as follows:

**“911.1 Features.** Where required by other sections of this code, a fire command center for fire department operations shall be provided and shall comply with the Fire Code and be approved by the fire chief.”

(14) Section 1008.2 of the International Building Code is amended to read as follows:

**“1008.2 Gates.** Gates serving the means of egress system shall comply with the requirements of this section. Gates used as a component in a means of egress shall conform to the applicable requirements for doors.

**Exceptions:**

- (1) Horizontal sliding or swinging gates exceeding the 4-foot (1219 mm) maximum leaf width limitation are permitted in fences and walls surrounding a stadium.
- (2) Security gates may be permitted across corridors or passageways in school buildings if there is a readily visible durable sign on or adjacent to the gate, stating ‘THIS GATE IS TO REMAIN SECURED IN THE OPEN POSITION WHENEVER THIS BUILDING IS IN USE’. The sign shall be in letters not less than one inch high on a contrasting background. The use of this exception may be revoked by the building official for due cause.”

(15) Chapter 11 of the International Building Code is deleted in its entirety and replaced with the following:

**“Chapter 11 - Accessibility**

**1101 Scope.** Buildings or portions of buildings shall be accessible to persons with disabilities in accordance with the following regulations:

- (1) For construction of buildings or facilities of the State and County Governments, compliance with section 103-50, Hawai‘i Revised Statutes, administered by the

Disability and Communication Access Board, State of Hawai'i.

- (2) Americans with Disabilities Act, administered and enforced by the U.S. Department of Justice.
- (3) Fair Housing Act, administered and enforced by the U.S. Department of Housing and Urban Development.
- (4) Other pertinent laws relating to disabilities shall be administered and enforced by agencies responsible for their enforcement.

Prior to the issuance of a building permit, the owner (or the owner's representative, professional architect, or engineer) shall submit a statement that all requirements, relating to accessibility for persons with disabilities, shall be complied with."

- (16) Section 1203.2.2 of the International Building Code is added to read as follows:

**"1203.2.2 Unvented Attic Spaces.** The attic space shall be permitted to be unvented when the design professional determines it would be beneficial to eliminate ventilation openings to reduce salt-laden air and maintain relative humidity 60 percent or lower to:

- (1) Avoid corrosion to steel components,
- (2) Avoid moisture condensation in the attic space, or
- (3) Minimize energy consumption for air conditioning or ventilation by maintaining satisfactory space conditions in both the attic and occupied space below."

- (17) Section 1603.3 of the International Building Code is amended to read as follows:

**"1603.3 Live loads posted.** Where the live loads for which each floor or portion thereof of a commercial or industrial building is or has been designed to exceed 100 psf (4.80 kN/m<sup>2</sup>), such design live loads shall be conspicuously posted by the owner in that part of each story in which they apply, using durable signs. It shall be unlawful to remove or deface such notices."

- (18) Section 1611.1 of the International Building Code is amended to read as follows:

**"1611.1 Design rain loads.** Each portion of a roof shall be designed to sustain the load of rainwater that will accumulate on it if the primary drainage system for that portion is blocked plus the uniform load caused by water that rises above the inlet of the secondary drainage system at its design flow. The design rainfall rate shall be based on the 100-year 1-hour rainfall rate indicated in Figure 1611.1 as published by the National Weather Service

or on other rainfall rates determined from approved local weather data.”

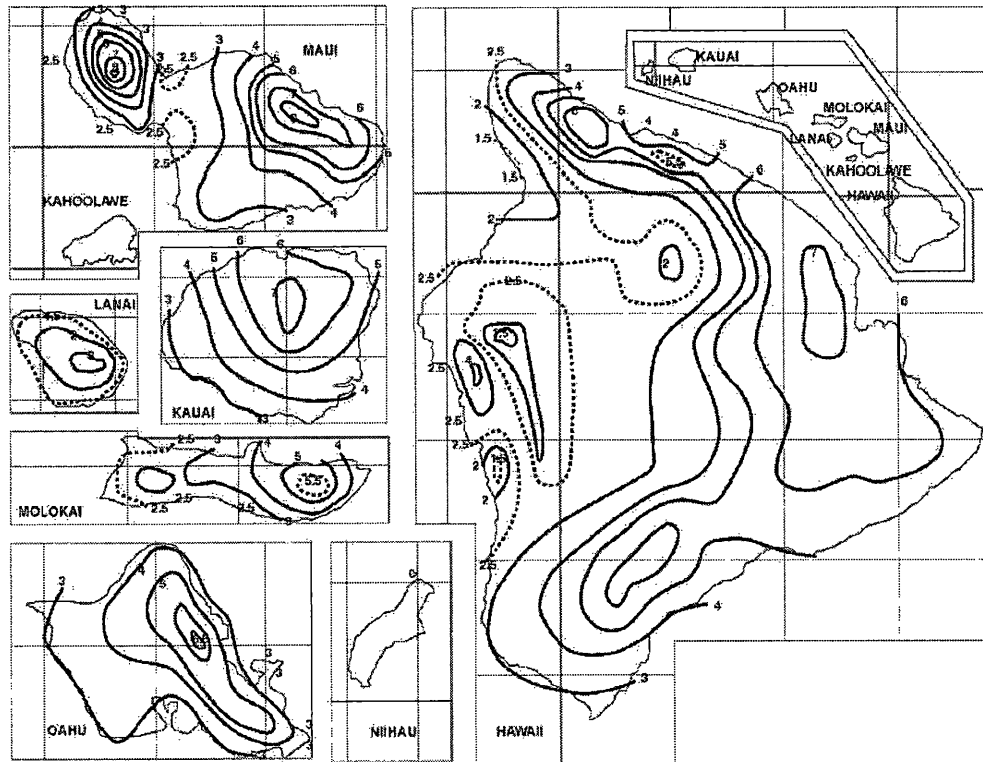

FIGURE 1611.1—continued  
100-YEAR, 1-HOUR RAINFALL (INCHES) HAWAII

For SI: 1 inch = 25.4 mm.

Source: National Weather Service, National Oceanic and Atmospheric Administration, Washington D.C.

- (19) Table 1613.5.6(1) in the International Building Code is amended to read as follows:

**TABLE 1613.5.6(1)**  
**SEISMIC DESIGN CATEGORY BASED ON**  
**SHORT-PERIOD RESPONSE ACCELERATIONS**

VALUE OF $S_{DS}$	Occupancy Category		
	I or II	III	IV
$S_{DS} < 0.167g$	A	A	A
$0.167g \leq S_{DS} < 0.33g$	B	B	C
$0.33g \leq S_{DS} < 0.50g$	C	C	D
$0.50 \leq S_{DS} < 0.60g$	C	D	D
$0.60g \leq S_{DS}$	D	D	D

- (20) Table 1613.5.6(2) in the International Building Code is amended to read as follows:

**TABLE 1613.5.6(2)**  
**SEISMIC DESIGN CATEGORY BASED ON**  
**1-SECOND PERIOD RESPONSE ACCELERATION**

VALUE OF $S_{DI}$	Occupancy Category		
	I or II	III	IV
$S_{DI} < 0.067g$	A	A	A
$0.067g \leq S_{DI} < 0.133g$	B	B	C
$0.133g \leq S_{DI} < 0.20g$	C	C	D
$0.20g \leq S_{DI} < 0.25g$	C	D	D
$0.25g \leq S_{DI}$	D	D	D

- (21) The definition of “Structural Observation” in Section 1702 of the International Building Code is amended to read as follows:

“STRUCTURAL OBSERVATION. Structural Observation defined in accordance with Hawai‘i Administrative Rules of the Department of Commerce and Consumer Affairs, Title 16, Chapter 115, implementing Hawai‘i Revised Statutes chapter 464. Structural observation does not include or waive the responsibility for the inspection required by Section 109, 1704 or other sections of this code.”

- (22) Section 1704.1 of the International Building Code is amended to read as follows:

“**1704.1 General.** Where application is made for construction as described in this section, the owner or the registered design professional in responsible charge acting as the owner’s agent shall employ one or more special inspectors to provide inspections during construction on the types of work listed under Sections 1704 and 1707. The special inspector shall be a qualified person who shall demonstrate competence, to the satisfaction of the building official, for inspection of the particular type of construction or operation requiring special inspection. These inspections are in addition to the inspections specified in Section 109.

**Exceptions:**

- (1) Special inspections are not required for work of a minor nature or as warranted by conditions in the jurisdiction as approved by the building official.

- (2) Special inspections are not required for building components unless the design involves the practice of professional engineering or architecture as defined by applicable state statutes and regulations governing the professional registration and certification of engineers or architects.
  - (3) Unless otherwise required by the building official, special inspections are not required for occupancies in Group R-3 as applicable in Section 101.2 and occupancies in Group U that are accessory to a residential occupancy including, but not limited to, those listed in Section 312.1.”
- (23) Section 1704.1.1 of the International Building Code is amended to read as follows:
- “1704.1.1 Statement of special inspections.** The construction drawings shall include a complete list of special inspections required by this section.”
- (24) Section 1704.1.2 of the International Building Code is amended to read as follows:
- “1704.1.2 Report requirement.** Special inspectors shall keep records of inspections. The special inspector shall furnish inspection reports to the owner, and licensed engineer or architect of record. Reports shall indicate that work inspected was done in conformance to approved construction documents. Discrepancies shall be brought to the immediate attention of the contractor for correction, then, if uncorrected, to the licensed engineer or architect of record and to the building official. The special inspector shall submit a final signed report to the owner and licensed engineer or architect of record, stating whether the work requiring special inspection was, to the best of the inspector’s knowledge, in conformance to the approved plans and specifications and the applicable workmanship provisions of this code. Prior to the final inspection required under Section 109.3.10, the licensed engineer or architect of record shall submit a written statement verifying receipt of the final special inspection reports and documenting that there are no known unresolved code requirements that create significant public safety deficiencies.”

- (25) Section 1705 of the International Building Code is deleted in its entirety.
- (26) Section 1709 of the International Building Code is amended to read as follows:

**“1709 Structural Observations.** Structural observations shall be performed in accordance with Hawai‘i Revised Statutes, chapter 464, section 5, administered and enforced by the department of commerce and consumer affairs.”

- (27) Section 1808.2.7 of the International Building Code is amended to read as follows:

**“1808.2.7 Splices.** Splices shall be constructed so as to provide and maintain true alignment and position of the component parts of the pier or pile during installation and subsequent thereto and shall be of adequate strength to transmit the vertical and lateral loads and moments occurring at the location of the splice during driving and under service loading. Splices occurring in the upper 10 feet (3048 mm) of the embedded portion of the pier or pile shall be capable of resisting at allowable working stresses the moment and shear that would result from an assumed eccentricity of the pier or pile load of 3 inches (76 mm), or the pier or pile shall be braced in accordance with Section 1808.2.5 to other piers or piles that do not have splices in the upper 10 feet (3048 mm) of embedment.”

- (28) Section 2104.1.9 of the International Building Code is added to read as follows:

**“2104.1.9 Cleanouts.** Cleanouts shall be provided for all grout pours over 5 feet 4 inches in height. Special provisions shall be made to keep the bottom and sides of the grout spaces, as well as the minimum total clear area required by ACI 530.1-05/ASCE 6-05/TMS 602-05 clean and clear prior to grouting.

**Exception:** Cleanouts are not required for grout pours 8 feet or less in height providing all of the following conditions are met:

- (1) The hollow masonry unit is 8-inch nominal width or greater with specified compressive strength  $f_m$  less than or equal to 1,500 psi;
- (2) Fine grout is used complying with ASTM C-476 minimum compressive strength of 2,500 psi; and
- (3) Special Inspection is provided.”

- (29) Section 2303.1.8 of the International Building Code is repealed and replaced in its entirety to read as follows:

**“2303.1.8 Preservative-treated wood.** Structural lumber, including plywood, posts, beams, rafters, joists, trusses, studs, plates, sills, sleepers, roof and floor sheathing, flooring and headers of new wood-frame buildings and additions shall be:

- (1) Treated in accordance with AWWA Standard U1 (UC1 thru UC4B) for AWWA Standardized Preservatives, all marked or branded and monitored by an approving agency. Incising is not required, providing that the retention and penetration requirements of these standards are met.
- (2) For SBX disodium octaborate tetrahydrate (DOT), retention shall be not less than 0.28 pcf  $B_2O_3$  (0.42 pcf DOT) for exposure to Formosan termites. All such lumber shall be protected from direct weather exposure as directed in AWWA UC1 and UC2.
- (3) For structural glued-laminated members made up of dimensional lumber, engineered wood products, or structural composite lumber, pressure treated in accordance with AWWA U1 (UC1 thru UC4B) or by Light Oil Solvent Preservative (LOSP) treatment standard as approved by the building official. Water based treatment processes as listed in paragraphs 1 and 2 are not allowed to be used on these products unless specified by a structural engineer for use with reduced load values and permitted by the product manufacturer.
- (4) For structural composite wood products, treated by non-pressure processes in accordance with AWWA Standard U1 (UC1, UC2 and UC3A) or approved by the building official.

**2303.1.8.1 Treatment.** Wood treatment shall include the following:

- (1) A quality control and inspection program which meets or exceeds the current requirements of AWWA Standards M2-01 and M3-03;
- (2) Inspection and testing for the treatment standards as adopted by this code shall be by an independent agency approved by the building official, accredited by

the American Lumber Standards Committee (ALSC) and contracted by the treating company;

- (3) Field protection of all cut surfaces with a preservative, which shall be applied in accordance with AWWA Standard M-4-02 or in accordance with the approved preservative manufacturer's ICC-Evaluation Services report requirements.

**2303.1.8.2 Labeling.** Labeling shall be applied to all structural lumber 2 inches or greater nominal thickness, with the following information provided on each piece as a permanent ink stamp on one face or on a durable tag permanently fastened to ends with the following information:

- (1) Name of treating facility;
- (2) Type of preservative;
- (3) AWWA use category;
- (4) Quality mark of third party inspection agency;
- (5) Retention minimum requirements; and
- (6) Year of treatment.

All lumber less than 2 inches in nominal thickness, shall be identified per bundle by means of a label consisting of the above requirements. Labels measuring no less than 6 inches by 8 inches shall be placed on the lower left corner of the strapped bundle.

**2303.1.8.3 Moisture Content of Treated Wood.** When wood pressure treated with a water-borne preservative is used in enclosed locations where drying in service cannot readily occur, such wood shall be at a moisture content of 19 percent or less before being covered with insulation, interior wall finish, floor covering or other material."

- (30) Section 2304.9.5 of the International Building Code is amended to read as follows:

**"2304.9.5 Fasteners in non-borate-preservative-treated and fire-retardant-treated wood.** Fasteners for preservative-treated and fire-retardant-treated wood, other than Borate (SBX, ZB) or LSOP treatments as approved in Section 2303.1.8 Preservative-Treated Wood, shall be of hot dipped zinc-coated galvanized steel, stainless steel, silicone bronze or copper. The coating weights for zinc-coated fasteners shall be in accordance with ASTM A 153.

**Exception:** Fasteners other than nails, timber rivets, wood screws and lag screws shall be permitted to be of mechanically deposited zinc-coated steel with coating weights in accordance with ASTM B 695, Class 55 minimum.

Fastenings for wood foundations shall be as required in AF&PA Technical Report No. 7.”

- (31) Section 2304.11 of the International Building Code is amended to read as follows:

**“2304.11 Protection against decay and termites.**

**2304.11.1 General.** Where required by this section, protection from decay and termites shall be provided by the use of naturally durable or preservative-treated wood.

**2304.11.2 Wood used above ground.** Structural lumber installed above ground shall be preservative-treated wood in accordance with Section 2303.1.8.

**2304.11.2.1 Soil Treatment and Termite Barriers.** Where structural lumber of wood frame buildings or structures are supported directly on the ground by a concrete slab, or concrete and/or masonry foundation Formosan subterranean termite protection shall be provided by either chemically treating the soil beneath and adjacent to the building or structure by a Hawai‘i licensed pest control operator, or stainless steel termite barrier, or other termite protection measures approved by the Building Official.

All soil treatment, stainless steel termite barrier, and termite protection measures shall be installed according to manufacturer’s recommendations for control of Formosan subterranean termites.

**2304.11.3 Wood in Ground Contact.** Wood supporting permanent buildings and structures, which is in direct soil contact or is embedded in concrete or masonry in direct contact with earth shall be treated to the appropriate commodity specification of AWPA Standard U1.

Wood in direct soil contact but not supporting any permanent buildings or structures shall be treated to the appropriate commodity specification of AWPA Standard U1 for ground contact.

**2304.11.4 Retaining Walls.** Wood in retaining or crib wall shall be treated to AWPA Standard U1.

**2304.11.5 Wood and Earth Separation.** Where wood is used with less than 6-inch vertical separation from earth (finish grade), it shall be treated for ground-contact use.

Where planter boxes are installed adjacent to wood frame walls, a 2-inch-wide (51 mm) air space shall be provided between the planter and the wall. Flashings shall be installed when the air space is less than 6 inches (152 mm) in width. Where flashing is used, provisions shall be made to permit circulation of air in the air space. The wood-frame wall shall be provided with an exterior wall covering conforming to the provisions of section 2304.6.

**2304.11.6 Under-Floor Clearance for Access and Inspection.** Minimum clearance between the bottom of floor joists or bottom of floors without joists and the ground beneath shall be 24 inches; the minimum clearance between the bottom of girders and the ground beneath shall be 18 inches.

**Exception:** Open slat wood decks shall have ground clearance of at least 6 inches for any wood member.

Accessible under-floor areas shall be provided with a minimum 18 inch-by 24 inch access opening, effectively screened or covered. Pipes, ducts and other construction shall not interfere with the accessibility to or within under-floor areas.

**2304.11.7 Wood used in retaining walls and cribs.** Wood installed in retaining or crib walls shall be preservative treated in accordance with AWPA U1 (Commodity Specifications A or F) for soil and fresh water use.

**2304.11.8 Weather Exposure.** All portions of timbers (over 5-inch nominal width) and glued-laminated timbers that form structural supports of a building or other structure shall be protected by a roof, eave, overhangs, flashings, or similar coverings.

All wood or wood composite panels, in weather-exposed applications, shall be of exterior type.

**2304.11.9 Water Splash.** Where wood-frame walls and partitions are covered on the interior with plaster, tile or similar materials and are subject to water splash, the framing shall be protected with approved waterproof paper conforming to section 1404.2.

**2304.11.10 Pipe and Other Penetrations.** Insulations around plumbing pipes shall not pass through ground floor slabs. Openings around pipes or similar penetrations in a concrete or masonry slab, which is in direct contact with earth, shall be filled with non-shrink grout, BTB, or other approved physical barrier.”

(32) Section 2308.1 of the International Building Code is amended to read as follows:

“**2308.1 General.** The requirements of this section are intended for conventional light-frame construction. Other methods are permitted to be used, provided a satisfactory design is submitted showing compliance with other provisions of this code. Interior nonload-bearing partitions, ceilings and curtain walls of conventional light-frame construction are not subject to the limitations of this section. Alternatively, compliance with AF&PA WFCM shall be permitted subject to the limitations therein and the limitations of this code.”

(33) Section 2701.1 of the International Building Code is amended to read as follows:

“**2701.1 Scope.** This chapter governs the electrical components, equipment and systems used in buildings and structures covered by this code. Electrical components, equipment and systems shall be designed and constructed in accordance with the provisions of the National Electrical Code, NFPA 70.”

(34) Section 2901.1 of the International Building Code is amended to read as follows:

“**2901.1 Scope.** The provisions of this chapter and the Uniform Plumbing Code shall govern the erection, installation, alteration, repairs, relocation, replacement, addition to, use or maintenance of plumbing equipment and systems. Plumbing systems and equipment shall be constructed, installed and maintained in accordance with the Uniform Plumbing Code and adopted amendments. Private sewage disposal systems shall conform to the International Private Sewage Disposal Code.”

(35) Section 3001.1 of the International Building Code is amended to read as follows:

“**3001.1 Scope.** This chapter shall be a guideline and governs the design, construction, installation, alteration and repair of elevators and conveying systems and their components. If this chapter conflicts with another applicable law of the jurisdiction, then said applicable law shall prevail over this chapter.”

(36) Section 3109.3 of the International Building Code is amended to read as follows:

**“3109.3 Public swimming pools.** Public swimming pools shall be completely enclosed by a fence at least 4 feet (1219 mm) in height or a screen enclosure. Openings in the fence shall not permit the passage of a 4-inch-diameter (102 mm) sphere. The fence or screen enclosure shall be equipped with self-closing and self-latching gates.

**EXCEPTION:** Swimming, dipping, or wading pools located on the premises of a hotel are not required to be enclosed.”

(37) Section 3405.1 of the International Building Code is amended to read as follows:

**“3405.1 Conformance.** The installation or replacement of glass shall be as required by Chapter 24 for new installations.”

(38) Section 3410.3.2 of the International Building Code is amended to read as follows:

**“3410.3.2 Compliance with other codes.** Buildings that are evaluated in accordance with this section shall comply with the State Fire Code.”

### **Article 3. Adoption, Amendment, and Addition of Appendices.**

#### **Division 1. Appendices of International Building Code Adopted.**

##### **Section 5A-3-1. Appendices not applicable.**

Provisions in the appendices of the International Building Code, 2006 Edition, shall not apply unless specifically adopted.

##### **Section 5A-3-2. Appendices adopted.**

The following appendices of the IBC are hereby adopted and incorporated by reference herein and made a part of this code, subject to the amendments hereinafter set forth in this article:

- (1) Appendix C, Group U-Agricultural Buildings; and
- (2) Appendix I, Patio Covers.

##### **Section 5A-3-3. Amendments to Appendix C; Group U – Agricultural Buildings.**

Section C101, General, is amended by adding the following:

**“C101.2 Horticulture buildings.** Buildings and structures of Group U Occupancy for horticultural use with covering of wire screen, cheesecloth, or non-rigid plastic sheets are not required to conform to the requirements of Chapters 4-9, 11-26, 28, 30,

31, 34 and 35 of this code when located in areas zoned for agricultural use and not part of any other structure.

**C101.3 Fences.**

**C101.3.1 General.** Fences shall be constructed in accordance with this code and all applicable County and State regulations.

**C101.3.2 Barbed or razor wire fences.** Barbed or razor wire shall not be used for construction of any fence.

**Exceptions:**

(a) Barbed or razor wire may be used in fences enclosing the following premises, provided that barbed or razor wire shall be placed along or above the height of 6 feet from the ground, subject to the approval of the fire department:

- (1) Any “public utility” as defined in section 269-1, Hawai‘i Revised Statutes;
- (2) Premises in industrial zoned districts and used for storage or handling of hazardous materials, and premises zoned I-2 or I-3, intensive or waterfront industrial districts which are used for industrial purposes and are not adjacent to premises used for other purposes;
- (3) Zoos for keeping animals and birds for public view or exhibition;
- (4) Jails, prisons, reformatories, and other institutions which are involved in law enforcement or military activities where security against entry is an important factor.

(b) Barbed wire may be used in premises used for pasturing livestock, including but not limited to: horses; cattle; sheep; goats; camelids; and pigs, or to keep wild animals out.

**Section C101.3.3 Construction barrier.** See Section 3306 for fences allowed during construction or demolition.”

**Division 2. Appendices Added to the International Building Code.**

**Section 5A-3-21. Appendices added to International Building Code.**

The following appendices are hereby added to the International Building Code and made a part of this code, as set forth in full in this article:

- (1) Appendix L, Factory-Built Housing;
- (2) Appendix M, Thatch Material on Exterior of Buildings – Protection Against Exposure Fires;

- (3) Appendix U, Hawai'i Hurricane Sheltering Provisions for New Construction;
- (4) Appendix W, Hawai'i Wind Design Provisions for New Construction;
- (5) Appendix X, Indigenous Hawaiian Architecture Structures; and
- (6) Appendix Y, Tiny Houses.

**Section 5A-3-22. Appendix L; Factory-built Housing.**

Appendix L is added to read as follows:

**“APPENDIX L  
FACTORY-BUILT HOUSING**

**SECTION L101  
APPLICABILITY**

**L101.1 Purpose.** These provisions are applicable to the design, construction, installation, and transportation of factory-built housing (FBH) within the County. Unless otherwise specified this article shall be applicable only to FBH which is sold or offered for sale to first users as defined below.

**Exception:** Manufactured homes manufactured and certified in accordance with the Manufactured Home Construction and Safety Standards as promulgated by the United States Department of Housing and Urban Development. Foundation, exterior stairs, additions and accessory structures shall comply with Article 1, Adoption of the International Building Code and International Residential Code for One- and Two-Family Dwellings.

All provisions of the building, housing, electrical, and plumbing codes shall be applicable unless indicated otherwise in this article.

**L101.2 Definitions.** The following terms are defined for specialized use within this article:

“Building official” means the director of the department of public works or the director’s authorized representative.

“Factory-built housing” means any structure or portion thereof designed primarily for residential occupancy by human beings, which is either entirely prefabricated or assembled at a place other than the building site.

“First user” means a person, firm or corporation who initially installs FBH within this State. A person who subsequently purchases an installed FBH is not a first user within the meaning of this definition.

“Insignia of approval” means a tag, tab, stamp, label or other device issued by the building official to indicate compliance with the statutes and these rules.

“Installation” means the assembly of FBH on site and the process of affixing FBH to land, a foundation or an existing building.

“Manufacture” means the process of making, fabricating, constructing, forming, or assembling a FBH at a place other than the building site.

“Site” means the parcel of land on which FBH is installed.

**L101.3 Building permit required.**

- (a) No person shall perform any of the following work or cause or permit the same to be done on any FBH in the County, without first obtaining a permit for this work from the building official:
  - (1) Manufacture, install, erect, construct, enlarge, alter, repair, relocate, improve, remove, convert, or demolish any FBH;
  - (2) Manufacture, erect, install, enlarge, alter, repair, remove, convert, or replace any electrical work; or
  - (3) Manufacture, erect, install, enlarge, alter, repair, remove, convert, or replace any plumbing, fire sprinkler, gas, or drainage piping work, or any fixture, gas appliance, water heating, or water treating equipment.
  
- (b) To obtain a permit, an applicant shall comply with sections: 5-4-1; 5-4-2, 5-4-3, 5-4-4, 5-4-5, 5-4-6, 5-4-7, and 5-4-8.

**L101.4 Building permit fee.** A fee for each building permit as set forth in section 5-7-3 of chapter 5, shall be paid to the building official.

**L101.5 Insignia of approval.**

- (a) FBH manufactured in this County which is sold or offered for sale to first users within this County shall bear the insignia of approval issued by the building official indicating that the FBH is in compliance with this article.
- (b) FBH manufactured outside the County shall bear the insignia of approval issued by any governmental or inspectional agency approved by the building official.

**L101.6 Performance of building, electrical, and plumbing work.**

- (a) All building, electrical, and plumbing work performed within the State of Hawai'i shall comply with State of Hawai'i contracting and licensing laws and regulations.
- (b) All building, electrical, and plumbing work to be performed at the factory outside of this state must be accomplished:
  - (1) Under the supervision of a licensed building contractor, licensed supervising electrician, or master plumber, respectively, of the state in which the factory is located, if the manufacturer submits a quality control manual which is approved by the building official; or
  - (2) By licensed building contractors, electricians, or plumbers, respectively, of the state in which the factory is located.

**L101.7 Inspections.**

- (a) Each and every FBH manufactured outside of this County shall be inspected by a governmental or inspectional agency approved by the building official in conformance with the quality assurance standards approved by the building official and in compliance with County of Hawai'i codes and regulations.
- (b) All manufacturing work, including building, electrical, and plumbing, shall be inspected in the factory by the building official to ensure compliance with the requirements of the construction code. It shall be the duty of the permit holder

or their agent, to cause the work to remain accessible and exposed for inspection purposes. All inspections of FBH shall comply with sections 5-8-1, 5-8-2, 5-8-3, 5-8-4, 5-8-5, 5-8-6, and 5-8-7.

**L101.8 Manufacturer's label.**

- (a) Each and every FBH manufactured outside of this County shall have a manufacturer's label on a metal plate showing the manufacturer's name, serial number of the building, manufacture date, design load criteria, and an inspection stamp by a governmental or inspectional agency approved by the building official securely fastened on the FBH;
- (b) Each and every FBH manufactured in the County of Hawai'i shall have a manufacturer's label on a metal plate showing the manufacturer's name, serial number of the building, manufacture date, design load criteria, and building official inspection stamp securely fastened on the FBH.

**L101.9 Transporting Factory-Built Housing.** The transportation of FBH shall be governed by the provisions of the County and State traffic codes.”

**Section 5A-3-23. Appendix M; Thatch Material on Exterior of Buildings - Protection Against Exposure Fires.**

Appendix M is added to read as follows:

**“APPENDIX M  
THATCH MATERIAL ON EXTERIOR OF BUILDINGS; PROTECTION AGAINST  
EXPOSURE FIRES**

**SECTION M101  
GENERAL**

**M101.1 General.** Thatched materials used on the roof on a building shall be protected by manually operated sprinkler heads, with adequate water supply, pipe size, and sprinkler head spacing in accordance with sprinkler system requirements set forth in this section.

Thatched materials used on the wall of a building shall be protected by manually operated outside sprinklers. Size and spacing of sprinklers and pipe size shall be in accordance with Chapter 7, “Outside Sprinklers and Protection Against Exposure Fires,” of the National Fire Codes of the National Fire Protection Association. Controls shall be set forth in this section.

**SECTION M102  
APPLICABILITY**

**M102.1 Applicability.** Thatched material on the exterior of buildings shall be permitted only upon buildings located in areas zone for resort (V Resort-Hotel by the Planning Department) uses which primarily service the tourist trade when approved by the building official.

The thatched material permitted in this section shall be used for decorative purposes on the roof or wall of buildings. The building, independent of the thatched material, shall comply with all applicable provisions of this appendix.

When thatched material is used as permitted in this section, and an appropriate permit is obtained therefore, outside sprinklers for protection against exposure fires shall be required as hereinafter provided.

**SECTION M103  
SPRINKLER**

**M103.1 General.** Sprinklers shall be located at the high point of the roof. Upright or pendant sprinklers shall be used for gable roofs. Sidewall sprinklers shall be used for shed roofs.

**M103.2 Spacing of Sprinklers.** The maximum width of roof with one row of sprinklers shall be as follows:

Roof Slope	Orifice Size (In inches)	Width of Roof
1:3 or greater	3/8	15'
1:3 or greater	1/2	20'
1:3 or greater	17/32	25'
Less than 1:3	3/8	10'
Less than 1:3	1/2	15'
Less than 1:3	17/32	20'

Maximum spacing of sprinklers on branch lines (along ridge) shall be as follows: 3/8-inch orifice – 6 feet; 1/2-inch orifice – 8 feet; 17/32-inch orifice – 10 feet.

Conical roofs may be protected with one sprinkler at the apex if the diameter of the roof does not exceed the width of roof referred to in this section.

Where the width of a roof exceeds the width allowed for one row of sprinklers, as provided in the table in this section, two or more rows of sprinklers shall be required. The rows of sprinklers shall be placed such that the entire roof area is protected.

**M103.3 Areas Protected.** Each area (zone) of thatched material that is separated from another thatched area by an open space of 20 feet or more or by incombustible construction of 20 feet or more shall be considered a separate area (zone).

Risers to each separate zone shall not be less than that shown in subsection M103.5, Riser and Pipe Size, except as modified as follows:

- (1) More than one zone may be protected by one valve, if the supply is adequate.
- (2) If one area (zone) is larger than can be protected with the existing supply, the zones can be subdivided into subzones if the following criteria are met: An area of at least 800 square feet is protected by the subzone control valve; there is at least a 10 percent overlap in coverage of adjoining subzones; and operation of the manual control valves will automatically transmit an alarm to the fire department.

**M103.4 Water Supply.** The sprinkling system shall have a separate connection to the water main in the street, to an approved automatic fire-extinguishing system supply line, to a wet standpipe supply line, or to a domestic supply of adequate size. The water supply required shall be determined from either of the following:

- (1) Flow per sprinkler for the largest zone, with residual pressure at the highest sprinkler at 15 pounds per square in with all heads operating, shall be as follows:

Orifice Size (In inches)	Gallons Per Minute
3/8	15
1/2	20
17/32	25

- (2) The flow shall be hydraulically calculated so as to discharge at least 0.11 gallons per minute per square foot of surface area to be sprinkled.

**M103.5 Riser and Pipe Size.** Pipe sizes shall be determined from the flow as calculated in subsection M103.4, Water Supply. However, no pipe less than one inch in size shall be used. The following table may be used in conjunction with this flow calculated for the selection of pipe or riser sizes.

Orifice Size (In inches)	Pipe or Riser Size							
	1"	1-1/4"	1-1/2"	2"	2-1/2"	3"	3-1/2"	4"
	No. of Sprinklers							
3/8	3	4	7	11	21	37	40	40
1/2	2	3	5	8	15	27	40	40
17/32	1	2	4	6	11	19	30	38

**M103.6 Number of Sprinklers Served.** The number of sprinklers on a branch line shall not exceed six. Center feet shall be used for six or more sprinklers. The number of sprinklers under control of each control valve shall not exceed forty. At the location of each valve, there shall be a drain connection and a 1/4-inch valve test connection to accommodate pressure gauge.

**M103.7 Material Installed Above Grade.** Piping shall be galvanized steel schedule 40 with galvanized malleable iron fittings or hard drawn copper with silver solder fittings. Pipes shall be securely fastened to the structure.

Valves shall be manual type approved and listed by the Underwriters' Laboratories or by other approved testing agencies. Valves shall be installed outdoors and so located as to be readily accessible in case of fire. Signs indicating the use of valves shall be conspicuously posted.

**M103.8 Local Alarm.** Any one system with 20 or more sprinklers under control of one valve shall be complemented with a local fire alarm, either electrically or mechanically operated."

**Section 5A-3-24. Appendix U; Hawai'i Hurricane Sheltering Provisions for New Construction.**

Appendix U is added to read as follows:

**“APPENDIX U  
HAWAI'I HURRICANE SHELTERING PROVISIONS FOR NEW  
CONSTRUCTION**

**Section U101. Community Storm Shelters.**

Chapter 4 is amended by adding Section 421 to read as follows:

**“SECTION 421  
COMMUNITY STORM SHELTERS**

**421.1 General.** In addition to other applicable requirements in this code, community storm shelters and the following specific Occupancy Category IV buildings shall be constructed in accordance with ICC/NSSA-500:

- (1) Designated earthquake, hurricane or other emergency shelters.
- (2) Designated emergency preparedness, communication, and operation centers and other facilities required for emergency response.

**421.1.1 Scope.** This section applies to the construction of storm shelters constructed as separate detached buildings or constructed as safe rooms within buildings for the purpose of providing safe refuge from storms that produce high winds, such as hurricanes. Such structures shall be designated to be hurricane shelters.

**421.2 Definitions.** The following words and terms shall, for the purposes of this chapter and as used elsewhere in this code, have the meanings shown herein.

**COMMUNITY STORM SHELTER.** A building, structure, or portions(s) thereof, constructed in accordance with ICC 500-08 ICC/NSSA Standard on the Design and Construction of Storm Shelters and designated for use during a severe wind storm event such as a hurricane.”

## **Section U102. Hawai'i Residential Safe Room.**

Chapter 4 is amended by adding Section 422 to read as follows:

### **“SECTION 422 HAWAI'I RESIDENTIAL SAFE ROOM**

**422.1 Performance-Based Design Criteria.** The Residential Safe Room shall meet the minimum performance specifications of Sections 422.1.1 through 422.9, and the owner of the Residential Safe Room shall comply with Section 422.10.

**422.1.1 Intent and Scope.** The intent of the Residential Safe Room is to temporarily provide an enhanced protection area that is either: (1) fully enclosed within a dwelling or within an accessory structure to a residence; or (2) a separate structure outside of the dwelling that meets standards pursuant to 422.1.2.1 or 422.1.2.2. All Residential Safe Rooms shall be designed and constructed to withstand the wind pressures, windborne debris impacts, and other requirements of this section.

#### **422.1.2 Alternative Standards.**

- (1) **Manufactured Safe Room Designs Subject to Approval.** A manufactured safe room or safe room kit may be substituted if documentation is submitted and approved by the building official. The safe room shall be engineered, tested, and manufactured to meet or exceed the criteria of this section.
- (2) **FEMA 320 Shelter Designs Permitted.** It shall be permissible to build FEMA Shelters of up to 64 square feet of floor area with walls up to 8 feet long that are built in accordance with construction details of FEMA 320.

**422.2 Site Criteria.** Residential Safe Rooms shall not be constructed within areas subject to stream flooding, coastal flooding or dam failure inundation within any of the following areas:

- (1) FEMA Special Flood Hazard Areas (SFHA) subject to rainfall runoff flooding or stream or flash flooding;

- (2) Coastal zones "V" or "A" identified in the Flood Insurance Rate Map (FIRM) issued by FEMA for floodplain management purposes, in which the flood hazard are tides, storm surge, waves, tsunamis, or a combination of these hazards; and
- (3) Areas subject to dam failure inundation as determined by the Department of Land and Natural Resources.

**422.3 Maximum Occupancy.** The safe room is permitted to be used for a maximum occupancy based on at least 15 square feet per person with a maximum of 8 persons in a room of up to 128 square feet of floor area.

**422.4 Provisions for Exiting.** The room shall be equipped with an inward-swinging door and an impact-protected operable window suitable for a means of alternative exiting in an emergency.

**422.5 Design for Dead, Live, Wind, Rain, and Impact Loads.**

**422.5.1 Structural Integrity Criteria.**

- (1) The safe room shall be built with a complete structural system and a complete load path for vertical and lateral loads caused by gravity and wind.
- (2) The building that the safe room is built within shall be assumed to be destroyed by the storm and shall not be taken as offering any protective shielding to the safe room enclosure.
- (3) The ceiling structure and wall shall be capable of supporting a superimposed debris load of the full weight of any building floors and roof above, but not less than 125 psf.
- (4) The safe room enclosure shall be capable of simultaneously resisting lateral and uplift wind pressures corresponding to a 160 mph 3-second peak gust, determined in accordance with ASCE Standard 7, Minimum Design Loads for Buildings and Other Structures, calculated using load and importance Factors of 1.0. The site exposure factor shall be based on exposure C. The gust factor and the directionality factor shall be taken as 0.85. Topographic wind amplification caused by mountainous terrain shall be considered in accordance with the building code.

Internal pressure shall be determined in accordance with ASCE – 7.

- (5) The safe room shall be anchored to a foundation system capable of resisting the above loading conditions.

**422.5.2 Windborne Debris Impact Protection of Building Enclosure Elements.** The entire enclosure of the safe room, including all walls, ceilings, and openings, fixed or operable windows, and all entry doors into the safe room, shall meet or exceed Level D requirements of ASTM E 1996 (Table 422.5-1). Any wall or ceiling penetration greater than 4 square inches shall be considered an opening.

**Exception:** Electrical outlet boxes and interior lighting switches not penetrating more than 2.5-inches into the interior wall surface and a plumbing piping or conduit not greater than 1.5-inch in diameter shall be exempted from this requirement.

**422.5.3 Cyclic Pressure Loading of Glazing and Protective Systems.** Impact protective systems shall meet the ASTM E 1996 cyclic pressure requirement for the loading given in Table 422.5-1.

**Table 422.5-1  
Windborne Debris Protection and Cyclic Pressure  
Criteria for Residential Safe Rooms**

ASTM E 1996 Missile Level Rating	Debris Missile Size	Debris Impact Speed	Enclosure Wall Ceiling, and Floor Cyclic Air Pressure Testing - maximum inward and maximum outward pressures
D	2 x 4 weighing 9.0 lb. +/- 0.25 lb., and with min. length 8 ft. +/- 4-inch	50 ft./sec. or at least 34 mph	35 psf inward 45 psf outward

**422.6 Ventilation.** The room shall be naturally ventilated to allow the enclosure to have approximately one air change every 2 hours. This requirement may be satisfied by 12 square inches of venting per occupant. There shall be at least two operable vents. The vents shall be protected by a cowling or other device

that shall be impact tested to comply with ASTM E 1996 Level D. Alternatively, the room shall be evaluated to determine if the openings are of sufficient area to constitute an open or partially enclosed condition as defined in ASCE 7.

**422.7 Communications.** The safe room shall be equipped with a phone line and telephone that does not rely on a separate electrical power outlet. Alternatively, a wireless telephone shall be permitted to rely on an Uninterruptible Power Supply (UPS) battery device.

**422.8 Construction Documents.** Construction documents for the Residential Safe Room shall be directly prepared by a Hawai'i licensed professional structural engineer.

**422.9 Special Inspection.** The construction or installation of the safe room shall be verified for conformance to the drawings in accordance with Chapter 17.

**422.10 Notification.** The owner of the safe room shall notify the State Department of Defense and county civil defense agency of the property's Tax Map Key or Global Positioning System coordinates."

**Section U102. State and County-owned Public High Occupancy Buildings - Design Criteria for Enhanced Hurricane Protection Areas.**

Chapter 4 is amended by adding Section 423 to read as follows:

**"SECTION 423**

**STATE AND COUNTY-OWNED HIGH OCCUPANCY BUILDINGS - DESIGN CRITERIA FOR ENHANCED HURRICANE PROTECTION AREAS**

**423.1 Intent.** The purpose of this section is to establish minimum life safety design criteria for enhanced hurricane protection areas in high occupancy state- and county-owned buildings occupied during hurricanes of up to Saffir Simpson Category 3.

**423.2 Scope.** This section shall apply to state- and county-owned buildings which are of Occupancy Category III and IV

defined by Table 1604.5 and of the following specific occupancies:

- (1) Enclosed and partially enclosed structures whose primary occupancy is public assembly with an occupant load greater than 300.
- (2) Health care facilities with an occupant load of 50 or more resident patients, but not having surgery or emergency treatment facilities.
- (3) Any other state- and county-owned enclosed or partially enclosed building with an occupant load greater than 5,000.
- (4) Hospitals and other health care facilities having surgery or emergency treatment facilities.

**Exception:** Facilities located within flood zone V and flood zone A that are designated by the owner to be evacuated during hurricane warnings declared by the National Weather Service, shall not be subject to these requirements.

#### **423.3 Site Criteria.**

**423.3.1 Flood and Tsunami Zones.** Comply with ASCE 24-05, Flood Resistant Design and Construction, based on provisions for Occupancy Category III.

- (1) Floor slab on grade shall be 1.5 foot above the Base Flood Elevation of the county's flood hazard map, or at higher elevation as determined by a modeling methodology that predicts the maximum envelope and depth of inundation including the combined effects of storm surge and wave actions with respect to a Category 3 hurricane.
- (2) Locate outside of V and Coastal A flood zones unless justified by site-specific analysis or designed for vertical evacuation in accordance with a method approved by the building official. When a building within a V or Coastal A zone is approved, the bottom of the lowest structural framing member of any elevated first floor space shall be 2 feet above the Base Flood Elevation of the county's flood hazard map, or at higher elevation as determined by a modeling methodology that predicts the maximum envelope and depth of inundation including the combined effects of

storm surge and wave actions with respect to a Category 3 hurricane.

- (3) Locate outside of Tsunami evacuation zones unless justified by site-specific analysis or designed for vertical evacuation in accordance with a method approved by the building official.

**423.3.2 Emergency Vehicle Access.** Provide at least one route for emergency vehicle access. The portion of the emergency route within the site shall be above the 100-year flood elevation.

**423.3.3 Landscaping and Utility Laydown Impact Hazards.** Landscaping around the building shall be designed to provide standoff separation sufficient to maintain emergency vehicle access in the event of mature tree blowdown. Trees shall not interfere with the functioning of overhead or underground utility lines, nor cause laydown or falling impact hazard to the building envelope or utility lines.

**423.3.4 Adjacent Buildings.** The building shall not be located within 1,000 feet of any hazardous material facilities defined by Table 1604.5. Unanchored light-framed portable structures shall be not permitted within 300 feet of the building.

**423.4 Enhanced Hurricane Protection Area Program Requirements.**

**423.4.1 Applicable Net Area.** At least 50 percent of the net square feet of a facility shall be constructed to qualify as an enhanced hurricane protection area. The net floor area shall be determined by subtracting from the gross square feet the floor area of excluded spaces, exterior walls, columns, fixed or movable objects, equipment or other features that under probable conditions cannot be removed or stored during use as a storm shelter.

**423.4.2 Excluded spaces.** Spaces such as mechanical and electrical rooms, storage rooms, attic and crawl spaces, shall not be considered as net floor area permitted to be occupied during a hurricane.

**423.4.3 Occupancy Capacity.** The occupancy capacity shall be determined by dividing the net area of the enhanced hurricane protection area by 15 square feet net floor area per person.

**423.4.4 Toilets and hand washing facilities.** Provide a minimum of 1 toilet per 50 enhanced hurricane protection area occupants and a minimum of 1 sink per 100 enhanced hurricane protection area occupants, as determined per Section 423.4.3, located within the perimeter of the enhanced hurricane protection area. These required toilet and hand-washing facilities are not in addition to those required for normal occupancy and shall be included in the overall facility fixture count.

**423.4.5 Accessibility.** Where the refuge occupancy accommodates more than 50 persons, provide an ADA-accessible route to a shelter area at each facility with a minimum of 1 wheelchair space for every 200 enhanced hurricane protection area occupants determined per Section 423.4.3.

**423.5 Design Wind, Rain, and Impact Loads.**

**423.5.1 Structural Design Criteria.** The building Main Wind Force Resisting System and structural components shall be designed per ASCE 7 for a 115 mph minimum peak 3-second gust design speed with a load factor of 1.6, and an Importance Factor for Occupancy Category III. Topographic and directionality factors shall be the site-specific values determined per Appendix W. Design for interior pressure based on the largest opening in any exterior facade or roof surface.

**423.5.2 Windborne Debris Missile Impact for Building Enclosure Elements.** Exterior glazing and glazed openings, louvers, roof openings and doors shall be provided with windborne debris impact resistance or protection systems conforming to ASTM E1996-05 Level D, i.e., 9 lb. 2 X 4 @ 50 fps (34 mph).

**423.5.3 Cyclic Pressure Loading of Impact Resistive Glazing or Windborne Impact Protective Systems.** Resistance to the calculated maximum inward and outward pressure shall be designed to conform to ASTM E1996-05.

**423.5.4 Windows.** All unprotected window assemblies and their anchoring systems shall be designed and installed to meet the wind load and missile impact criteria of this section.

**423.5.5 Window Protective Systems.** Windows may be provided with permanent or deployable protective systems, provided the protective system is designed and installed to meet the wind load and missile impact criteria and completely covers the window assembly and anchoring system.

**423.5.6 Doors.** All exterior and interior doors subject to possible wind exposure and/or missile impact shall have doors, frames, anchoring devices, and vision panels designed and installed to resist the wind load and missile impact criteria or such doors, frames, anchoring devices, and vision panels shall be provided with impact protective systems designed and installed to resist the wind load and missile impact criteria of this section.

**423.5.7 Exterior envelope.** The building enclosure, including walls, roofs, glazed openings, louvers and doors, shall not be perforated or penetrated by windborne debris, as determined by compliance with ASTM E1996-05 Level C.

**423.5.8 Parapets.** Parapets shall satisfy the wind load and missile impact criteria of the exterior envelope.

**423.5.9 Roofs.**

**423.5.9.1 Roof Openings.** Roof openings (e.g., HVAC fans, ducts, skylights) shall be provided with protection for the wind load and missile impact criteria of Sections 423.5.2 and 423.5.3.

**423.5.9.2 High Wind Roof Coverings.** Roof coverings shall be specified and designed according to the latest ASTM Standards for high wind uplift forces.

**423.5.9.3 Roof Drainage.** Roofs shall have adequate slope, drains and overflow drains or scuppers sized to accommodate 100-year hourly rainfall rates in accordance with Section 1611.1, but not less than 2-inches per hour for 6 continuous hours.

## **423.6 Ventilation.**

**423.6.1 Mechanical ventilation.** Mechanical ventilation as required per the International Mechanical Code. Air intakes and exhausts shall be designed and installed to meet the wind load and missile impact criteria of Sections 423.5.2 and 423.5.3.

**423.6.2 HVAC Equipment anchorage.** HVAC equipment mounted on roofs and anchoring systems shall be designed and installed to meet the wind load criteria. Roof openings for roof-mounted HVAC equipment shall have a 12-inch-high curb designed to prevent the entry of rain water.

**423.7 Standby Electrical System Capability.** Provide a standby emergency electrical power system per Chapter 27 and NFPA 70 Article 700 Emergency Systems and Article 701 Legally Required Standby Systems, which shall have the capability of being connected to an emergency generator or other temporary power source. The emergency system capabilities shall include:

- (1) An emergency lighting system,
- (2) Illuminated exit signs,
- (3) Fire protection system(s), alarm and sprinkler, and
- (4) Minimum mechanical ventilation for health/safety purposes.

**423.7.1 Emergency Generator.** When emergency generators are pre-installed, the facility housing the generator, permanent or portable, shall be an enclosed area designed to protect the generators from wind and missile impact. Generators hardened by the manufacturer to withstand the area's design wind and missile impact criteria shall be exempt from the enclosed area criteria requirement.

## **423.8 Quality assurance.**

### **423.8.1 Information on Construction Documents.**

Construction Documents shall include design criteria, the occupancy capacity of the enhanced hurricane protective area, and Project Specifications shall include opening protection devices. Floor plans shall indicate all enhanced hurricane protection area portions of the facility and exiting routes there

from. The latitude and longitude coordinates of the building shall be recorded on the construction documents.

**423.8.2 Special Inspection.** In addition to the requirements of Chapter 17, special inspections shall include at least the following systems and components:

- (1) Roof cladding and roof framing connections.
- (2) Wall connections to roof and floor diaphragms and framing.
- (3) Roof and floor diaphragm systems, including collectors, drag struts and boundary elements.
- (4) Vertical windforce-resisting systems, including braced frames, moment frames and shear walls.
- (5) Windforce-resisting system connections to the foundation.
- (6) Fabrication and installation of systems or components required to meet the impact-resistance requirements of Section 1609.1.2.

**Exception:** Fabrication of manufactured systems or components that have a label indicating compliance with the wind-load and impact-resistance requirements of this code.

**423.8.3 Quality Assurance Plan.** A construction quality assurance program shall be included in the Construction Documents, including:

- (1) The materials, systems, components and work required to have special inspection or testing by the building official or by the registered design professional responsible for each portion of the work.
- (2) The type and extent of each special inspection.
- (3) The type and extent of each test.
- (4) Additional requirements for special inspection or testing for seismic or wind resistance.
- (5) For each type of special inspection, identification as to whether it will be continuous special inspection or periodic special inspection.

**423.8.4 Peer Review.** Construction Documents shall be independently reviewed by a Hawai'i-licensed Structural Engineer. A written opinion report of compliance shall be submitted to State Civil Defense, the Building Official, and the owner.

**423.9 Maintenance.** The building shall be periodically inspected every three years and maintained by the owner to ensure structural integrity and compliance with this section. A report of inspection shall be furnished to State Civil Defense.

**423.10 Compliance Re-certification when Altered, Deteriorated, or Damaged.** Alterations shall be reviewed by a Hawai'i-licensed structural engineer to determine whether any alterations would cause a violation of this section. Deterioration or damage to any component of the building shall require an evaluation by a Hawai'i-licensed structural engineer to determine repairs necessary to maintain compliance with this section."

**Section 5A-3-25. Appendix W; Hawai'i Wind Design Provisions for New Construction.**

Appendix W is added to read as follows:

**“APPENDIX W  
HAWAI'I WIND DESIGN PROVISIONS FOR NEW CONSTRUCTIONS**

**W101 Revisions to Chapter 16.** When Appendix W is adopted, wind design shall be in accordance with Chapter 16 as amended by Sections W101.1 through W101.10.

**W101.1 Revisions to Section 1603.1.** Section 1603.1 is amended to read as follows:

**“1603.1 General.** Construction documents shall show the size, section, and relative locations of structural members with floor levels, column centers and offsets dimensioned. The design loads and other information pertinent to the structural design required by Sections 1603.1.1 through 1603.1.8 shall be indicated on the construction documents.

**Exception:** Construction documents for buildings constructed in accordance with the conventional light-frame construction provisions of Section 2308 shall indicate the following structural design information:

- (1) Floor and roof live loads.
- (2) Ground snow load,  $P_g$ .
- (3) Basic wind speed (3-second gust) and Effective wind speed  $V_{eff}$  (3-second gust), miles per hour (mph)(km/hr) and wind exposure.

- (4) Seismic design category and site class.
- (5) Flood design data, if located in flood hazard areas established in Section 1612.3.”

**W101.2 Revisions to Section 1603.1.4.** Section 1603.1.4 is amended to read as follows:

**“1603.1.4 Wind Design Data.** The following information related to wind loads shall be shown, regardless of whether wind loads govern the design of the lateral-force-resisting system of the building:

- (1) Basic wind speed (3-second gust), miles per hour (km/hr),  $V$ , and effective windspeed  $V_{eff}$ .
- (2) Wind importance factor  $I$ , and building category.
- (3) Wind exposure, if more than one wind exposure is utilized, the wind exposure for each applicable wind direction shall be indicated.
- (4) The applicable internal pressure coefficient.
- (5) Components and cladding. The design wind pressures in terms of psf ( $kN/m^2$ ) used for the design of exterior components, and cladding not specifically designed by the registered design professional.”

**W101.3 Revisions to Section 1609.1.1.** Section 1609.1.1 is amended to read as follows:

**“1609.1.1 Determination of wind loads.** Wind loads on every building or structure shall be determined in accordance with Chapter 6 of ASCE 7. Minimum values for Directionality Factor,  $K_d$ , Velocity Pressure Exposure Coefficient,  $K_z$ , and Topographic Factor,  $K_{zt}$ , shall be determined in accordance with Section 1609. The type of opening protection required, the basic wind speed and the exposure category for a site is permitted to be determined in accordance with Section 1609 or ASCE 7. Wind shall be assumed to come from any horizontal direction and wind pressures shall be assumed to act normal to the surface considered.

**Exceptions:**

- (1) Subject to the limitations of Section 1609.1.1.1, the provisions of SBCCI SSTD 10 shall be permitted for applicable Group R-2 and R-3 buildings.

- (2) Subject to the limitations of Section 1609.1.1.1, residential structures using the provisions of the AF &PA WFCM.
- (3) Designs using NAAMM FP 1001.
- (4) Designs using TIA/EIA-222 for antenna-supporting structures and antennas.”

**W101.4 Revisions to Section 1609.1.2.** Section 1609.1.2 is amended to read as follows:

**“1609.1.2 Protection of openings.** In wind-borne debris regions, glazing in building shall be impact-resistant or protected with an impact-resistant covering meeting the requirements of an approved impact-resisting standard or ASTM E 1996 and of ASTM E 1886 referenced therein as follows:

- (1) Glazed openings located within 30 feet (9144 mm) of grade shall meet the requirements of the Large Missile Test of ASTM E 1996.
- (2) Glazed openings located more than 30 feet (9144 mm) above grade shall meet the provisions of the Small Missile Test of ASTM E 1996.

**Exceptions:**

- (1) Wood structural panels with a minimum thickness of 7/16 inch (11.1 mm) and a maximum panel span of 8 feet (2438 mm) shall be permitted for opening protection in one- and two-story buildings. Panels shall be precut so that they shall be attached to the framing surrounding the opening containing the product with the glazed opening. Panels shall be secured with the attachment hardware provided. Attachments shall be designed to resist the components and cladding loads determined in accordance with the provisions of ASCE 7. Attachment in accordance with Table 1609.1.2 is permitted for buildings with a mean roof height of 33 feet (10,058 mm) or less where wind speeds do not exceed 130 mph (57.2 m/s).
- (2) Glazing in Occupancy Category I buildings as defined in Section 1604.5, including greenhouses that are occupied for growing plants on a production or research basis, without public access shall be permitted to be unprotected.

- (3) Glazing in Occupancy Category II, III or IV buildings located over 60 feet (18,288 mm) above the ground and over 30 feet (9,144 mm) above aggregate surface roofs located within 1,500 feet (458 m) of the building shall be permitted to be unprotected.
- (4) Glazing in Occupancy Category II and III buildings that can receive positive external pressure in the lower 60 feet (18,288 mm) shall be assumed to be openings unless such glazing is impact-resistant or protected with an impact-resistant system.

**Exception:** Glazing in Occupancy Category III buildings defined by Table 1604.5 of the following occupancies shall be provided with windborne debris protection:

- (a) Covered structures whose primary occupancy is public assembly with an occupant load greater than 300.
- (b) Health care facilities with an occupant load of 50 or more resident patients, but not having surgery or emergency treatment facilities.
- (c) Any other public building with an occupant load greater than 5,000.

**1609.1.2.1 Building with openings.** Where glazing is assumed to be an opening in accordance with Section 1609.1.2, the building shall be evaluated to determine if the openings are of sufficient area to constitute an open or partially enclosed building as defined in ASCE 7. Open and partially enclosed buildings shall be designed in accordance with the applicable provisions of ASCE 7. Partially enclosed Occupancy R-3 buildings shall also include a residential safe room in accordance with Section 422, Hawai'i Residential Safe Room.

**1609.1.2.2 Louvers.** Louvers protecting intake and exhaust ventilation ducts not assumed to be open that are located within 30 ft (9,144 mm) of grade shall meet requirements of an approved impact-resisting standard or the Large Missile Test of ASTM E 1996.

**TABLE 1609.1.2**  
**WIND-BORNE DEBRIS PROTECTION FASTENING SCHEDULE**  
**FOR WOOD STRUCTURAL PANELS <sup>a,b,c</sup>**

FASTENER TYPE	FASTENER SPACING		
	Panel span ≤ 4 feet	4 feet < Panel span ≤ 6 feet	6 feet < Panel span ≤ 8 feet
No. 6 screws	16"	12"	9"
No. 8 screws	16"	16"	12"

For SI: 1 inch = 25.4 mm, 1 foot = 304.8 mm, 1 pound = 0.454 kg,

1 mile per hour = 1.609 km/h.

- a. This table is based on a maximum wind speed (3-second gust) of 130 mph and mean roof height of 33 feet or less.
- b. Fasteners shall be installed at opposing ends of the wood structural panel. Fasteners shall be located a minimum of 1 inch from the edge of the panel.
- c. Fasteners shall be long enough to penetrate through the exterior wall covering a minimum of 1.75 inches into wood wall framing; a minimum of 1.25 inches into concrete block or concrete; or into steel framing by at least three threads. Fasteners shall be located a minimum of 2.5 inches from the edge of concrete block or concrete.
- d. Where screws are attached to masonry or masonry/stucco, they shall be attached utilizing vibration-resistant anchors having a minimum withdrawal capacity of 490 pounds."

**W101.4.1 Revisions to Section 1609.2.** Section 1609.2 is amended to read as follows:

**"1609.2 Definitions.** The following words and terms shall, for the purposes of Section 1609, have the meanings shown herein.

**HURRICANE-PRONE REGIONS.** Areas vulnerable to hurricanes defined as:

- (1) The U.S. Atlantic Ocean and Gulf of Mexico coasts where the basic wind speed is greater than 90 mph (40 m/s) and
- (2) Hawai'i, Puerto Rico, Guam, Virgin Islands and American Samoa.

WIND-BORNE DEBRIS REGION. Portions of hurricane-prone regions that are within 1 mile (1.61 km) of the coastal mean high water line where the basic wind speed is 110 mph (48 m/s) or greater; or portions of hurricane-prone regions where the basic wind speed is 120 mph (53 m/s) or greater.”

**W101.5 Revisions to Section 1609.3.** Section 1609.3 is amended to read as follows:

**“1609.3 Basic wind speed and Topographic and Directionality Factors.** The basic wind speed, in mph, for the determination of the wind loads shall be determined by Figure 1609.

Special wind regions near mountainous terrain and valleys are accounted within the Topographic Factor defined in Section 1609.3.3. Wind speeds derived from simulation techniques shall only be used in lieu of the basic wind speeds given in Figure 1609 when, (1) approved simulation or extreme-value statistical-analysis procedures are used (the use of regional wind speed data obtained from anemometers is not permitted to define the hurricane wind speed risk in Hawai‘i) and (2) the design wind speeds resulting from the study shall not be less than the resulting 700-year return period wind speed divided by  $\sqrt{1.6}$ .”

**W101.6 Addition of Section 1609.3.2.** Section 1609.3.2 is added to read as follows:

**“1609.3.2 Effective basic wind speed conversion.** For Section 2308.10.1, the provisions of ASCE Section 6.4, and the exceptions permitted under Section 1609.1.1, the basic wind speed value used for determination of the wind loads, shall be the Effective Basic Wind Speed,  $V_{eff}$ , determined by Figure 1609.1.1.1, which adjusts the basic wind speed for special topographic wind regions.”

**W101.7 Addition of Effective Wind Speed Contour Maps.**  
 Figure 1609.1.1.1(a) is added as follows:

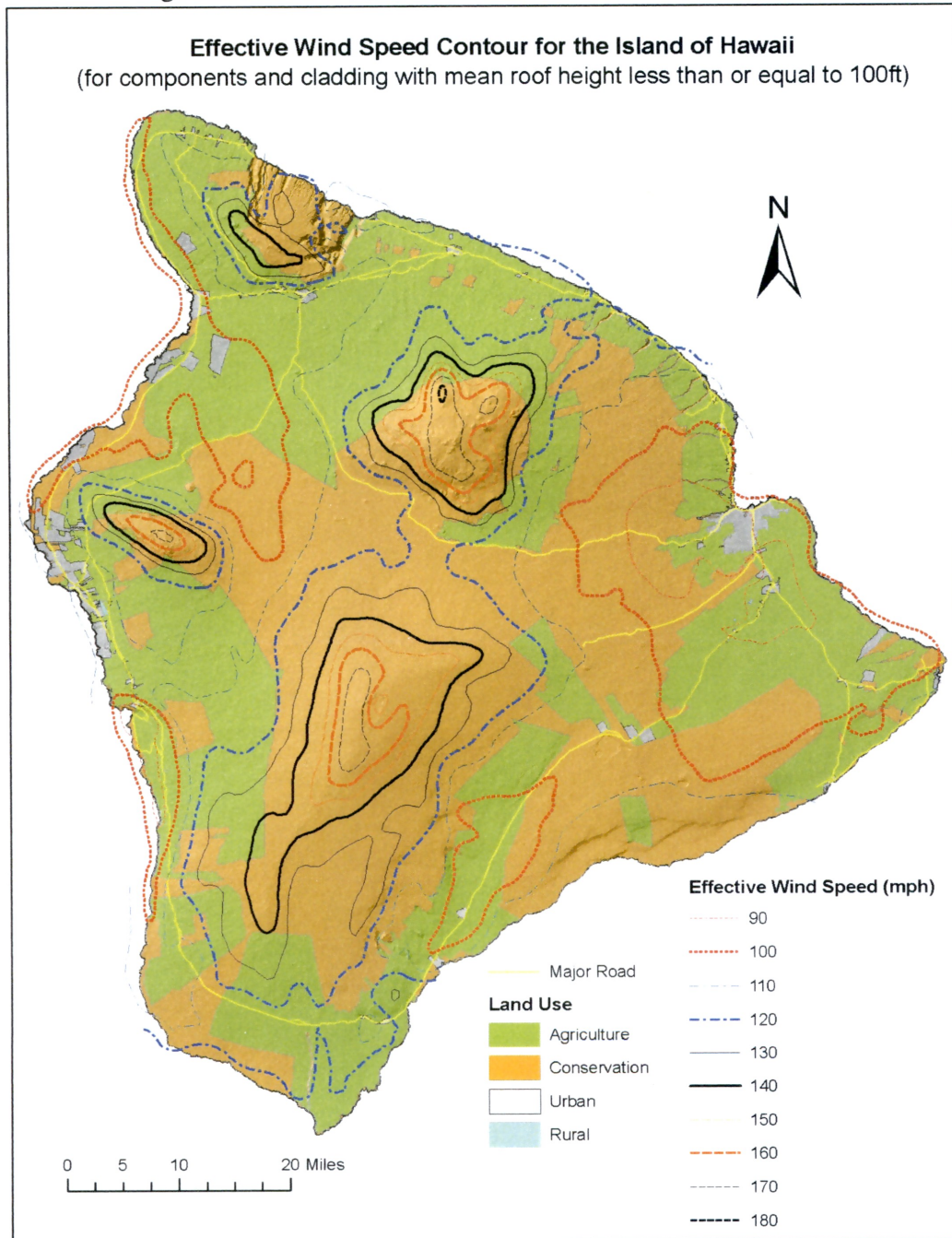

Figure 1609.1.1.1(a)  
 County of Hawai'i Effective Basic Wind Speed,  $V_{eff}$ , for Components  
 and Cladding for Buildings less than 100 ft. tall

**W101.8 Addition of Section 1609.3.3.** Section 1609.3.3 is added to read as follows:

**“1609.3.3 Topographic Effects.** Wind speed-up effects caused by topography shall be included in the calculation of wind loads by using the factor  $K_{zt}$ , where  $K_{zt}$  is given in Figure 1609.3.3(a).

**Exception:** Site-specific probabilistic analysis of directional  $K_{zt}$  based on wind-tunnel testing of topographic speed-up shall be permitted to be submitted for approval by the Building Official.”

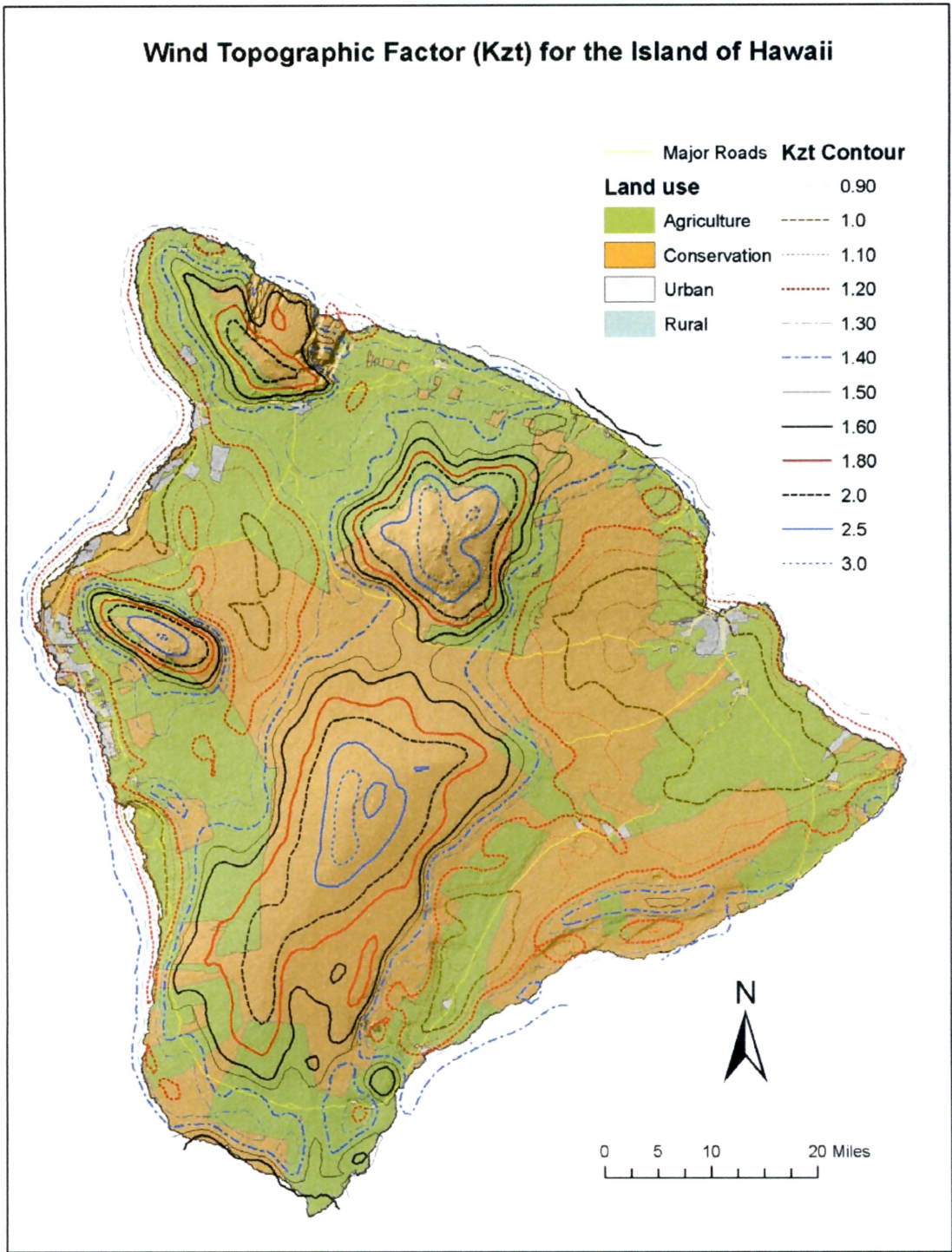

Figure 1609.3.3(a)  
County of Hawai'i Peak Gust Topographic Factor  $K_{zt}$

**W101.9 Directionality Factor.** Section 1609.3.4 is added to read as follows:

**“1609.3.4 Directionality Factor.** The wind directionality factor,  $K_d$ , shall be determined from Tables 1609.3.4(a) and 1609.3.4(b).

**Table 1609.3.4(a)(1)  
 $K_d$  Values for Main Wind Force Resisting Systems Sited in Hawai‘i County <sup>a,b</sup>**

Topographic Location on the Island of Hawai‘i	Main Wind Force Resisting Systems		Main Wind Force Resisting Systems with totally independent systems in each orthogonal direction		Biaxially Symmetric and Axisymmetric Structures of any Height and Arched Roof Structures
	Mean Roof Height less than or equal to 100 ft.	Mean Roof Height greater than 100 ft.	Mean Roof Height less than or equal to 100 ft.	Mean Roof Height greater than 100 ft.	
Sites in North Kohala, South Kohala, South Kona, South Hilo, and Puna Districts at an elevation not greater than 3000 ft.	0.65	0.70	0.70	0.75	0.85
All other sites	0.70	0.80	0.75	0.80	0.95

<sup>a</sup> The values of  $K_d$  for other non-building structures indicated in ASCE-7 Table 6-4 shall be permitted.

<sup>b</sup> Site-specific probabilistic analysis of  $K_d$  based on wind-tunnel testing of topography and peak gust velocity profile shall be permitted to be submitted for approval by the Building Official, but  $K_d$  shall have a value not less than 0.65.

**Table 1609.3.4(b)(1)**  
 **$K_d$  Values for Components and Cladding of Buildings Sited in Hawai'i County <sup>a,b</sup>**

Topographic Location on the Island of Hawai'i	Components and Cladding		
	Mean Roof Height less than or equal to 100 ft.	Mean Roof Height greater than 100 ft.	Occupancy Category IV Buildings and Structures
Sites in North Kohala, South Kohala, South Kona, South Hilo, and Puna Districts at an elevation not greater than 3000 ft.	0.65	0.70	0.75
All other sites	0.75	0.80	0.85

<sup>a</sup> The values of  $K_d$  for other non-building structures indicated in ASCE-7 Table 6-4 shall be permitted.

<sup>b</sup> Site-specific probabilistic analysis of  $K_d$  based on wind-tunnel testing of topography and peak gust velocity profile shall be permitted to be submitted for approval by the Building Official, but in any case subject to a minimum value of 0.65."

**W101.10 Addition of Exposure category maps.** Section 1609.4.4 is added to read as follows:

**“1609.4.4 Exposure category maps.** Exposure categories are permitted to be determined using Figure 1609.4.4(a).

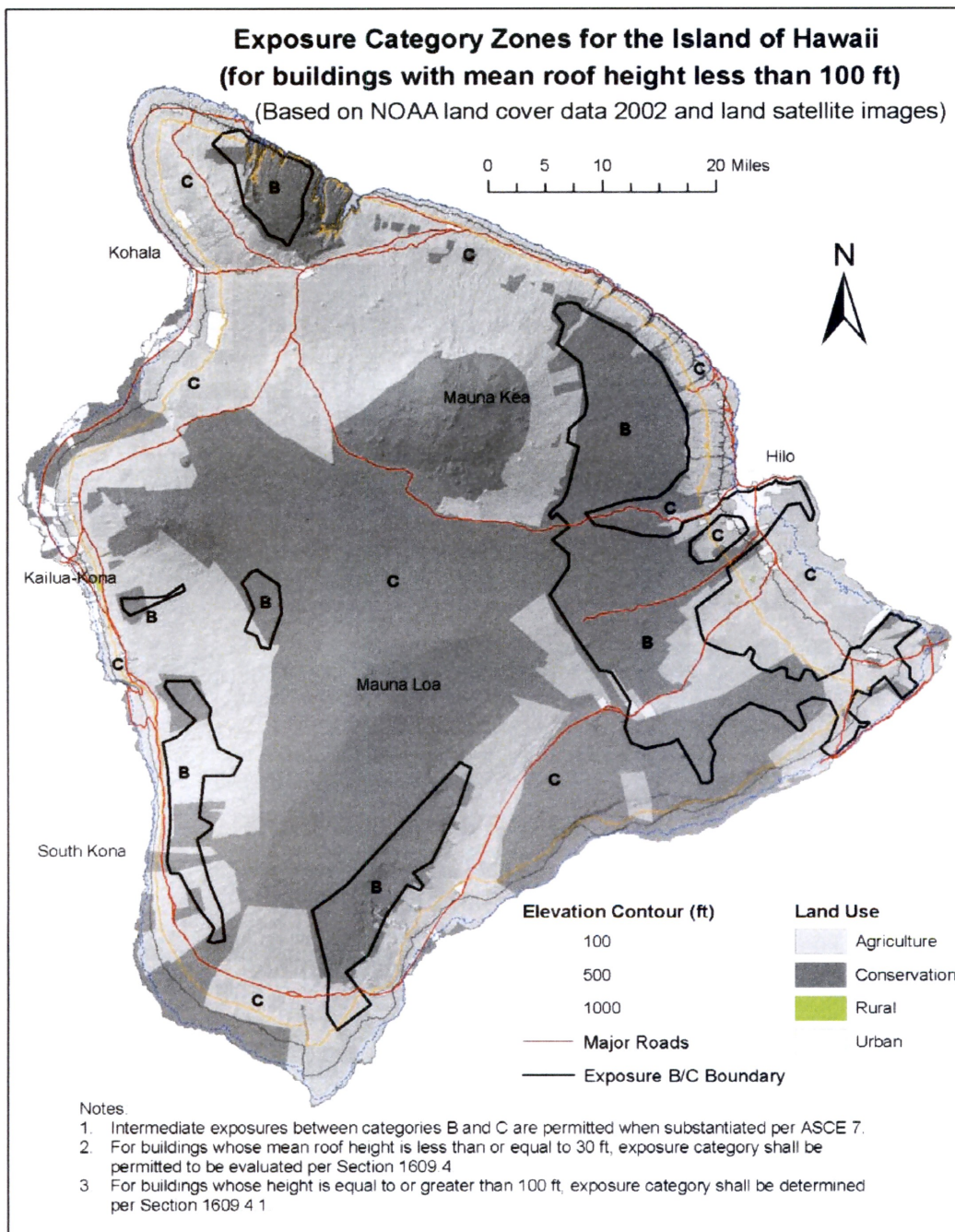

Figure 1609.4.4(a)  
 Exposure Category Zones for Hawai'i County

**W102 Revisions to Chapter 23.** When Appendix W is adopted, wood construction shall be in accordance with Chapter 23 as amended by Sections W102.1 and W102.2.

**W102.1 Revisions to Section 2308.2.1.** Section 2308.2.1 is amended to read as follows:

**“2308.2.1 Basic wind speed greater than 100 mph.** Where the Effective Basic Wind Speed exceeds 100 mph, the provisions of the AF&PA WFCM, or the SBCCI SSTD 10 are permitted to be used.”

**W102.2 Revisions to Table 2308.10.1.** Table 2308.10.1 is amended to read:

**TABLE 2308.10.1  
REQUIRED RATING OF APPROVED UPLIFT CONNECTORS (pounds)<sup>a,b,c,d,e,f,g,h,i</sup>**

Effective Basic Wind Speed $V_{eff}$ , 3-sec gust	Roof Span (feet)							Overhangs (pounds/ft) <sup>d</sup>
	12	20	24	28	32	36	40	
85	-72	-120	-144	-168	-192	-216	-240	-38.55
90	-91	-152	-182	-213	-243	-274	-304	-43.22
100	-131	-218	-262	-305	-349	-392	-436	-53.36
110	-175	-292	-350	-409	-467	-526	-584	-64.56
120	-240	-400	-480	-560	-640	-720	-800	-76.83
130	-304	-506	-607	-708	-810	-911	-1012	-90.17

For SI: 1 inch = 25.4 mm, 1 foot = 304.8 mm, 1 mile per hour = 1.61 km/hr, 1 pound = 0.454 Kg, 1 pound/foot = 14.5939 N/m.

- a. The uplift connection requirements are based on a 30-foot mean roof height located in Exposure B. For Exposure C and for other mean roof heights, multiply the above loads by the adjustment coefficients below.

EXPOSURE	Mean Roof Height (feet)									
	15	20	25	30	35	40	45	50	55	60
B	1.00	1.00	1.00	1.00	1.05	1.09	1.12	1.16	1.19	1.22
C	1.21	1.29	1.35	1.40	1.45	1.49	1.53	1.56	1.59	1.62

For SI: 1 inch = 25.4 mm, 1 foot = 304.8 mm, 1 mile per hour = 1.61 km/hr, 1 pound = 0.454 Kg, 1 pound/foot = 14.5939 N/m.

- b. The uplift connection requirements are based on the framing being spaced 24 inches on center. Multiply by 0.67 for framing spaced 16 inches on center and multiply by 0.5 for framing spaced 12 inches on center.

- c. The uplift connection requirements include an allowance for 10 pounds of dead load.
- d. The uplift connection requirements do not account for the effects of overhangs. The magnitude of the above loads shall be increased by adding the overhang loads found in the table. The overhang loads are also based on framing spaced 24 inches on center. The overhang loads given shall be multiplied by the overhang projection and added to the roof uplift value in the table.
- e. The uplift connection requirements are based upon wind loading on end zones as defined in Figure 6-2 of ASCE 7. Connection loads for connections located a distance of 20 percent of the least horizontal dimensions of the building from the corner of the building are permitted to be reduced by multiplying the table connection value by 0.7 and multiplying the overhang load by 0.8.
- f. For wall-to-wall and wall-to-foundation connections, the capacity of the uplift connector is permitted to be reduced by 100 pounds for each full wall above. (For example, if a 500-pound rated connector is used on the roof framing, a 400-pound rated connector is permitted at the next floor level down.)
- g. Interpolation is permitted for intermediate values of basic wind speeds and roof spans.
- h. The rated capacity of approved tie-down devices is permitted to include up to a 60-percent increase for wind effects where allowed by material specifications.
- i.  $V_{eff}$  is given by Figure 1609.1.1.1.”

**Section 5A-3-26. Appendix X; Indigenous Hawaiian Architecture Structures.**

Appendix X is added to read as follows:

**“APPENDIX X  
INDIGENOUS HAWAIIAN ARCHITECTURE STRUCTURES**

**SECTION X101  
GENERAL**

**X101.1 Scope.** The provisions of this appendix shall apply exclusively to Indigenous Hawaiian Architecture Structures. The purpose of these provisions is to acknowledge and establish procedures for designing and constructing indigenous Hawaiian architecture structures.

**X101.2 Publications incorporated by reference.** The following publications are incorporated by reference and made a part of these provisions. Where there is a conflict between Appendix X and the referenced documents, Appendix X shall prevail.

- (1) "Hawaiian Thatched House" (1971), by Russell A. Apple, published by the United States Department of the Interior,
- (2) "Hale Construction Standards" (2000), by Francis Sinenci and Bill Sides,
- (3) "The Hawaiian Grass House in Bishop Museum" (1988), by Catherine C. Summers, and
- (4) "Arts and Crafts of Hawaii, Section II, Houses" (1957) by Te Rangi Hiroa (Peter H. Buck)

**X101.3 Definitions.** For purposes of this appendix, the following words and terms shall have the meanings shown herein. Refer to Chapter 2 for general definitions.

**CERTIFIED HALE BUILDER.** Means a person who has obtained a certificate of completion for satisfactorily completing a course in Hawaiian hale construction from the University of Hawai'i, or any of its community colleges, or as approved by the Building Official.

**GROUP OF STRUCTURES.** A group of indigenous Hawaiian architecture structures that are in close proximity to each other and have an aggregate floor area of 1,800 square feet or less.

**INDIGENOUS HAWAIIAN ARCHITECTURE STRUCTURE or HALE.** A structure that is consistent with the design, construction methods and uses of structures built by Hawaiians in the 1800's, which uses natural materials found in the Hawaiian islands, and complies with this appendix and references.

**SEPARATION.** The clear distance between two structures.

**SETBACK.** The clear distance between a structure and a property line.

## **SECTION X201 MATERIAL REQUIREMENTS**

**X201.1 Hale Materials.** Hale shall be constructed using only materials grown and harvested in the State of Hawai'i.

**X201.2 Wood Framing Material.** The wood members for the hale, such as posts and rafters, shall be, but not limited to

hardwoods of unmilled, straight sections of trunks or branches of the following species:

- (1) Casaurina equisitifolia (ironwood).
- (2) Prosopis-allid (kiawe).
- (3) Eucalyptus robusta (eucalyptus).
- (4) Psidium cattleianum (strawberry guava).
- (5) Metrosideros polymorpha (ohia).
- (6) Rizophora mangle (mangrove).

**Exception:** Ardisia elliptica (inkberry) may be used only for roof purlins as an alternative to specified woods listed in Items 1 through 6.

**X201.3 Roofing and Siding.** Thatched roofing and siding materials for the hale may be any grass or leaf material grown and harvested in the State of Hawai'i, to include but not be limited to pili, kualohia, pueo, kawelu, sugar-cane leaves, and ti leaves.

**X201.4 Cord.** Natural or synthetic cord used for lashing structural members of the hale shall be 400 pound test. Cord used for tying floating purlins and thatched materials shall be 100 pound test. All cord used on the hale shall be shades of green, tan, brown or black.

**X201.5 Metal Prohibited.** Metal shall not be used for the construction of the hale.

## SECTION X202 SIZE AND LOCATION

**X202.1 Height and Size Limitation.** Hale shall be one-story, detached structure(s) not to exceed 1,800 square feet. Hale shall not exceed the size indicated in Table X202.1.

**Table X202.1  
Maximum Size of Hale (feet)**

Hale Halawai	Hale Ku'ai	Hale Noa	Hale Wa'a
30 X 60	14 X 20	14 X 24	30 X 60

**X202.2 Zoning Requirements.** Hale shall comply with minimum yard requirements in chapter 25, Zoning Code, Hawai'i County Code.

**X202.3 Minimum Separation.** The minimum separation between a hale and another structure shall be at least 10 feet for

a one-story structure; 15 feet for a two-story structure; or a distance equal to the height of the hale, whichever is more. The minimum separation between two hale shall be at least 10 feet or a distance equal to the height of the taller hale.

**X202.4 Hale Noa.** Hale noa structures may only be constructed on property where a separate residence exists on the property.

**SECTION X203  
ALLOWABLE AND PROHIBITED USES**

**X203.1 Allowable uses.** To the extent permitted by other applicable law, allowable uses for hale structures shall be in accordance with Table X203.1.

**Table X203.1  
Allowable Use for Each Hale Type**

Use	Hale Halawai	Hale Ku'ai	Hale Noa	Hale Wa'a
Eating (ai)	Allowed	Allowed	Not permitted	Allowed
Assembling (halawai)	Allowed	Allowed	Not permitted	Allowed
Sleeping (moe)	Not permitted	Not permitted	Allowed	Not permitted
Retailing (e.g., fruits) (ku'ai)	Allowed	Allowed	Not permitted	Allowed
Storage (papa'a)	Not permitted	Allowed	Not permitted	Allowed

**X203.2 Prohibited Uses and Activities.** The following uses and activities shall be prohibited from occurring within or near the hale:

- (1) Cooking.
- (2) Open flames.
- (3) Generators.
- (4) Extension cords.
- (5) Electrical switches, fixtures, or outlets.
- (6) Plumbing faucets, fixtures, or drains.
- (7) Power tools.
- (8) No screen, mesh, plastic or any other similar material shall be attached to the hale.

- (9) Hale shall not be used as a food establishment as defined in the administrative rules adopted by the State of Hawai'i, Department of Health.

**X203.3 Maintenance.** The hale shall be maintained by the owner to ensure structural integrity. Repairs for maintenance of the hale shall not require additional building permits.

**SECTION X301  
FIRE PROTECTION**

**X301.1 Fire Protection Classifications.** Fire protection for Indigenous Hawaiian architecture structures shall be as required in Table X301.1.

**Table X301.1  
Fire Protection Requirements Based on Setback**

<b>CLASS</b>	<b>SETBACK REQUIREMENTS</b>	<b>FIRE PROTECTION REQUIREMENTS</b>
A	<p>The structure (or a group of structures) is:</p> <ol style="list-style-type: none"> <li>1. Located at least 100 feet from any existing structure on the same or neighboring properties; and</li> <li>2. Located at least 100 feet from any property line, except as follows:               <ol style="list-style-type: none"> <li>a. If the property line abuts a public way, the 100 feet minimum setback for that property line shall be reduced by the width of the public way,</li> <li>b. If the property line abuts the shoreline, the minimum setback for that property line shall be the shoreline setback, or</li> <li>c. For any hale ku'ai in the agricultural district that is less than 200 square feet, that is completely open on three sides, and that is used as an agricultural products stand and if the property line abuts a public way, the minimum setback for that property line shall be 15 feet.</li> </ol> </li> </ol>	<p>No fire protection is required for the structure.</p>
B	<p>The structure (or a group of structures) that conforms to applicable zoning setback requirements but does not satisfy Class A setback requirements.</p>	<p>Automatic fire sprinkler system shall be installed in accordance with design standards in Section X301.2. An electrical permit is required for fire sprinklers systems.</p>

**X301.2 Automatic Fire Sprinklers.** The design standards for automatic fire sprinklers for Class B indigenous Hawaiian architecture structures shall be in accordance with NFPA 13.

**Exception:** The design standards for automatic fire sprinklers for Class B indigenous Hawaiian architecture structures shall be permitted as follows:

- (1) 18 gallons per minute for a single head at 140 square feet maximum coverage of roof area.
- (2) 13 gallons per minute for each subsequent head at 140 square feet maximum coverage of roof area per head.
- (3) The minimum supply pressure at the base of the riser shall not be less than 40 pounds per square inch.
- (4) The minimum residual pressure at the highest sprinkler shall be not less than 12 pounds per square inch.
- (5) Sprinkler head spacing shall not exceed 14 feet.
- (6) Sprinkler heads shall be open type upright, pendent, or sidewall with 1/2-inch or 17/32-inch orifice and have a wax corrosion resistant coating.
- (7) The total number of sprinklers on a branch shall not exceed 6 heads.
- (8) The total number of sprinklers shall not exceed the quantity shown in the following table:

Piping Size	Number of Sprinklers
1 inch diameter	2 sprinklers
1¼ inch diameter	3 sprinklers
1½ inch diameter	5 sprinklers
2 inch diameter	10 sprinklers
2½ inch diameter	30 sprinklers
3 inch diameter	60 sprinklers

- (9) The above pipe schedule shall not apply to hydraulically designed systems.
- (10) The water density shall not be less than 0.10 gpm per square foot.
- (11) The source of water may be by domestic water meters, detector check meter, underground well, storage tank, swimming pool, ponds, etc., but must meet the design requirements for adequate pressure and duration.

- (12) Water supply shall be sufficient to provide 30 minutes duration.
- (13) If domestic water meters are used as the source of water for the fire sprinklers, without a storage tank and booster pump, the maximum number of heads shall not exceed the following table:

Size of Water Meter	Number of Sprinklers
5/8 inch water meter	1 sprinkler
3/4 inch water meter	2 sprinklers
1 inch water meter	3 sprinklers
1½ inch water meter	7 sprinklers
2 inch water meter	11 sprinklers
3 inch water meter	27 sprinklers

- (14) The piping material shall be hard drawn copper with silver solder or brazed fittings, or carbon steel with corrosion-resistant coatings. Plastic pipes shall not be allowed, except for below grade supply pipes.
- (15) Fire sprinkler system shall be actuated by smoke detectors located at the highest points of the roof and spaced as recommended by the manufacturer.
- (16) Flow control valves shall be either hydraulically or electrically operated with a manual override switch.
- (17) Where the width of a roof exceeds the width allowed for one row of sprinklers, two or more rows of sprinklers shall be placed such that the entire roof area is protected.
- (18) Prevailing wind direction shall be considered in the placement of sprinklers.
- (19) Deflectors for sprinklers shall be parallel with the roof surface or tilted slightly towards the peak of the roof.
- (20) Fire sprinklers system shall have a local alarm activated by a smoke detector.

**X301.3 Certification of Water Supply.** For any hale that requires fire protection pursuant to X301.1, the applicant shall provide a certification from a licensed engineer or a licensed C-20 contractor that the water supply for the fire sprinkler system has been tested and is capable of delivering the required fire flow for 30 minutes duration.

**X302 Smoke Alarm.** Any hale used for sleeping shall have an approved battery operated smoke alarm installed in the hale.

**SECTION X401  
DESIGN STANDARDS**

**X401.1 General Design standards.** All types of hale shall be designed and constructed in accordance with the standards set out in this section.

- (1) The minimum diameter size of all structural members shall be measured at the member's midpoint, except that the minimum diameter size of posts shall be measured at the smaller end. For structure sizes not specifically shown in the tables, the requirements in the next larger width size shall be applicable.
- (2) The specifications for structural members were estimated based on no wind loads. Hale shall be constructed to allow all thatching materials to separate from the structure prior to adding significant loads.
- (3) The mix formula for mortar specified in these rules shall be one part portland cement, four parts clean sand, and sufficient fresh water to make the mixture workable.
- (4) Every hale, except hale noa, shall have at least two sides completely open.
- (5) Lashing and thatching methods shall comply with illustrations found in "Arts and Crafts of Hawai'i" or "The Hawaiian Grass House in Bishop Museum."

**X402 Allowable Designs.** Hale shall be designed and constructed in accordance with the requirements in Sections 402.1 through 402.4.

**X402.1 Hale Halawai.** Each end of the Hale Halawai may be open or thatched. The ends may also be constructed with a thatched roof hip as an alternate design. Hale Halawai shall be designed in accordance with the following schematics and illustrations. Structural components for Hale Halawai shall meet the size and spacing requirements in Table X402.1(a). Foundations for Hale Halawai shall be designed in accordance with Table X402.1(b).

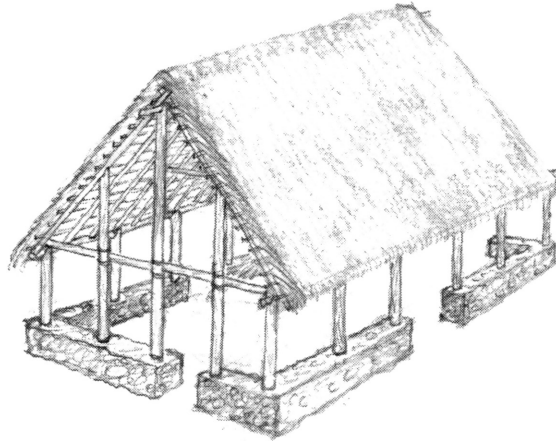

***HALE HALAWAI***  
Open End Style

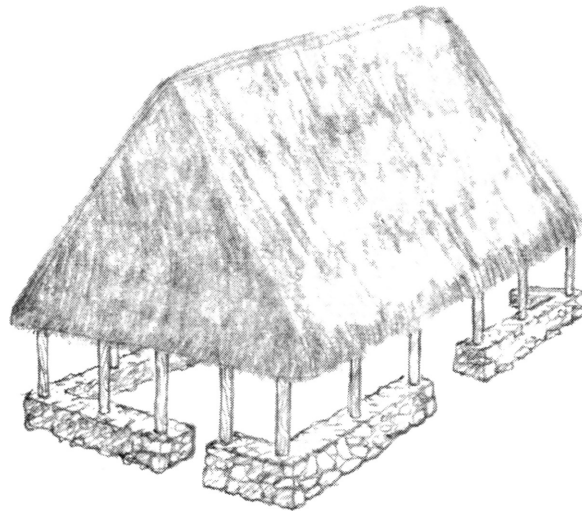

***HALE HALAWAI***  
Thatched End Style

## FRAMING SCHEMATIC

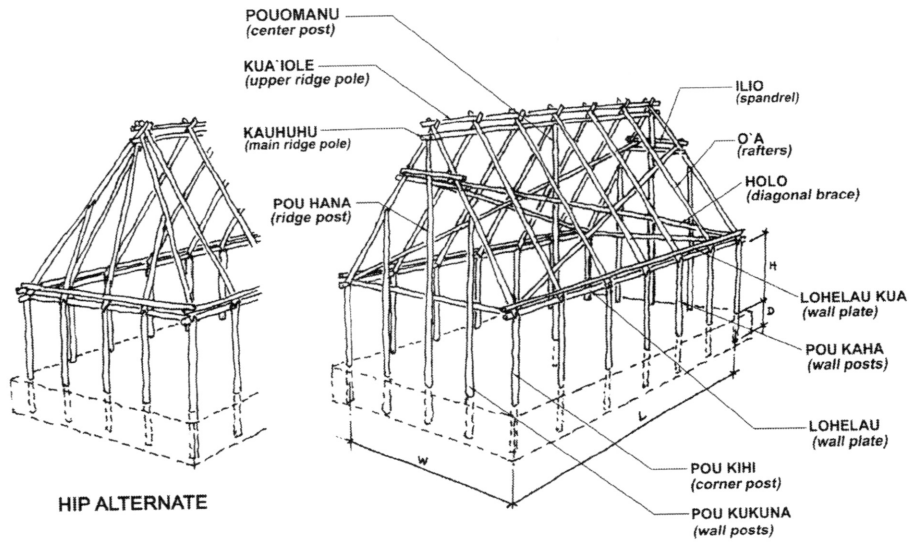

**Table X402.1(a)**  
**Size and Spacing Requirements for Structural Components used**  
**in Hale Halawai**

Size W x L x H	<i>Pou KihU</i>	<i>Pou Kukuna</i> & <i>Pou Kaha</i>	<i>Pou Hana</i>	<i>Pouomanu</i>	<i>O'a</i>	<i>Kuaiole</i> & <i>Holo</i>	<i>Kauhuhu</i>	<i>Lohelau</i>	Maximum post spacing (feet)	Maximum rafter spacing (feet)
	Minimum Diameter (inches)									
12' x 20' x 7'	4	3½	4	4	3½	2½	3	3	5	3
14' x 24' x 7'	4	4	4½	4½	3½	2½	3	3½	5	3
24' x 30' x 7'	5	4½	4½	4½	4	2½	3	3½	5	3
25' x 50' x 7'	5½	5	5½	5½	4	2½	3	3½	5	3
30' x 60' x 7'	6	5½	6	6	4½	2½	3	4	5	3

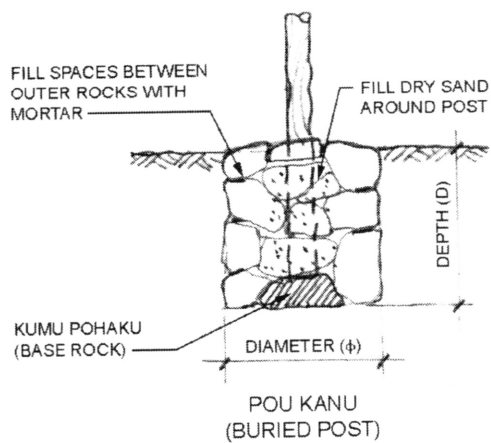
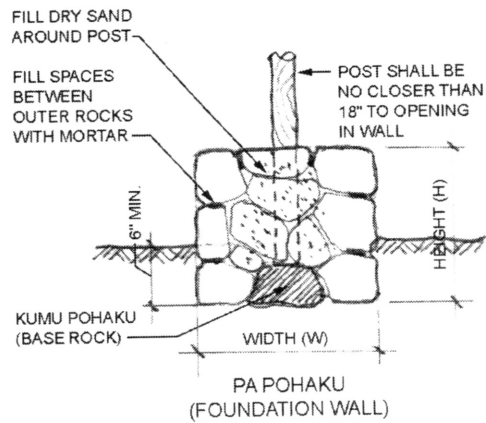
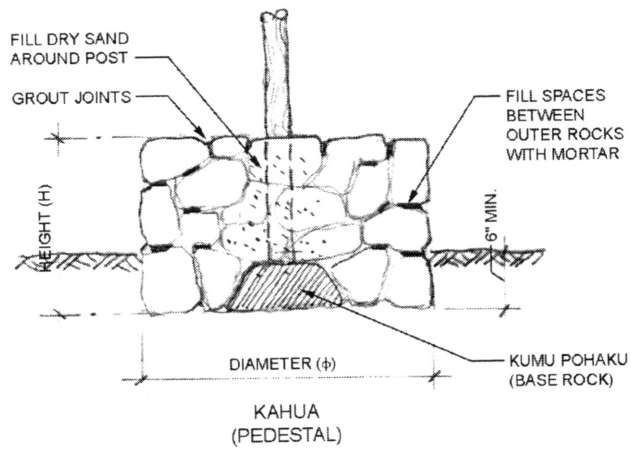
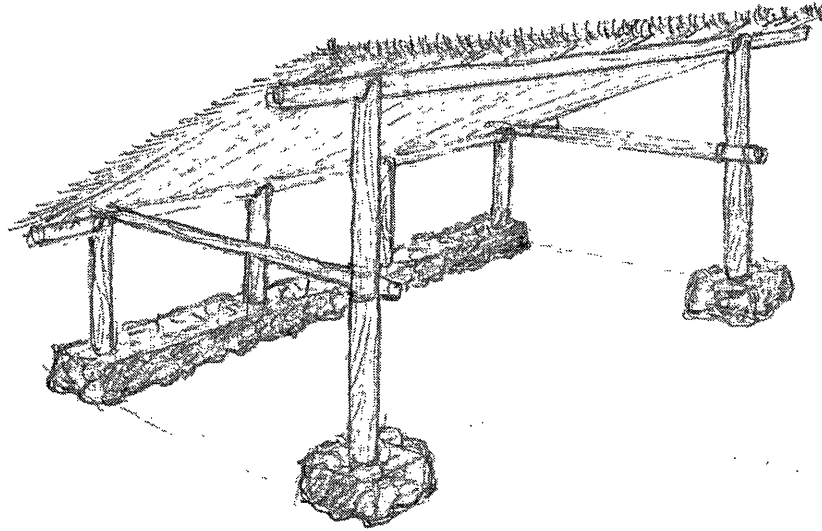

**Table X402.1(b)**  
**Foundation Design for Hale Halawai**

Size (W x L x H)	Foundation Type		
	Kahua Diameter x Height	Pa Pohaku Width x Height x Length	Pou Kanu Diameter x Depth
12' x 20' x 7'	3'6"φ x 24"H	2'6"W x 2'8"H x 4'0"L	30"φ x 2'8"D
14' x 24' x 7'	3'8"φ x 24"H	2'6"W x 2'8"H x 4'0"L	30"φ x 2'9"D
24' x 30' x 7'	4'0"φ x 30"H	3'0"W x 3'0"H x 4'0"L	36"φ x 3'0"D
25' x 50' x 7'	4'0"φ x 30"H	3'0"W x 3'0"H x 4'0"L	36"φ x 3'0"D
30' x 60' x 7'	4'0"φ x 30"H	3'0"W x 3'3"H x 4'0"L	36"φ x 3'3"D

~

**X402.2 Hale Ku'ai.** Hale Ku'ai shall be designed in accordance with the following schematics and illustrations. Structural components for Hale Ku'ai shall meet the size and spacing requirements in Table X402.2(a). Foundations for Hale Ku'ai shall be designed in accordance with Table X402.2(b).



***HALE KU'AI***  
**SHED STYLE**

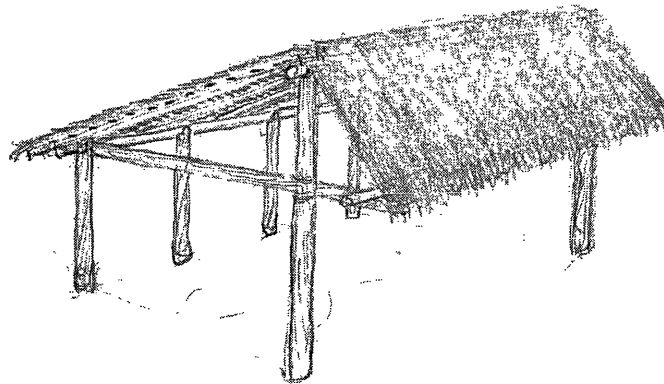

***HALE KU'AI***  
**GABLE STYLE**

## FRAMING SCHEMATIC 1

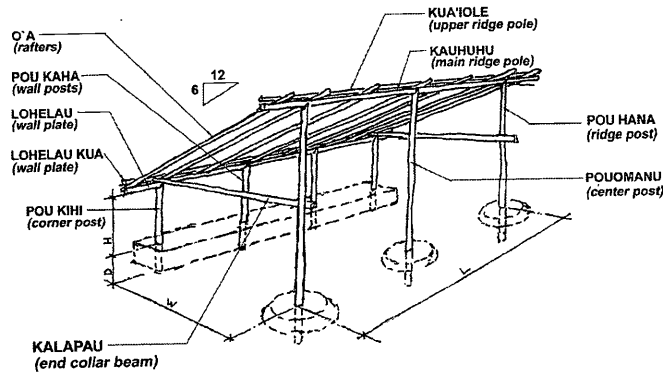

## FRAMING SCHEMATIC 2

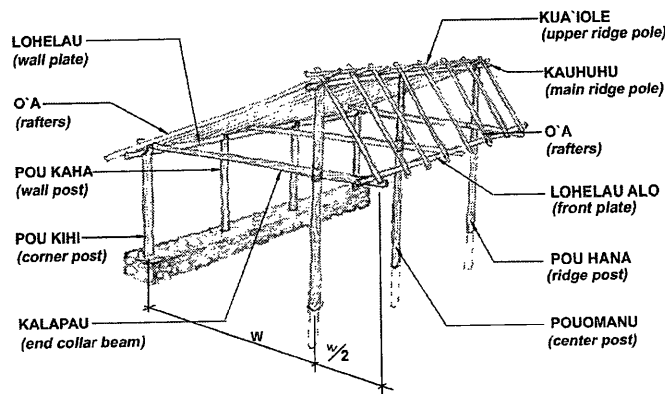
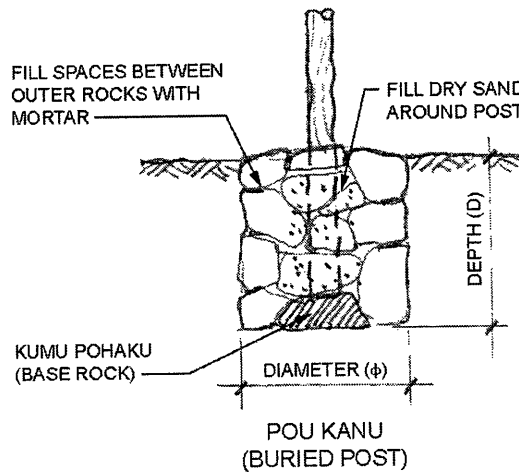
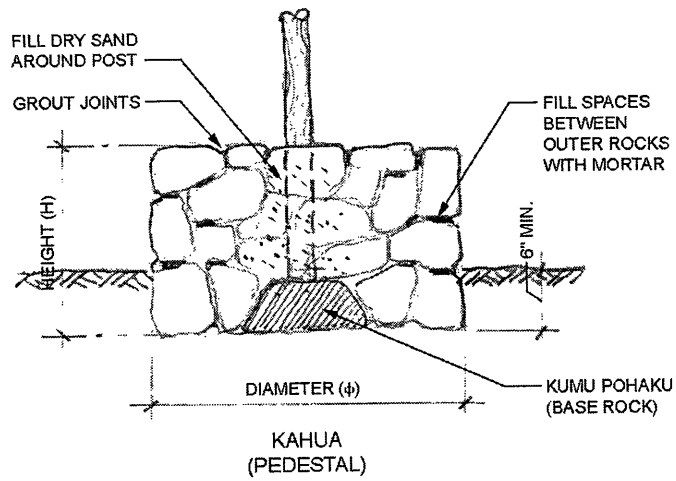

**Table X402.2(a)**  
**Size and Spacing Requirements for Structural Components used in Hale Ku'ai**

Size (W x L x H)	<i>Pou Kihī</i> <sup>a</sup>	<i>Pou Kaha</i> <sup>a</sup>	<i>Pou Hana</i> <sup>b</sup>	<i>Pouo Manu</i> <sup>b</sup>	<i>O'a</i>	<i>Kuaiole &amp; Holo</i>	<i>Kauhuhu</i>	<i>Lohelau</i>	Maximum rafter spacing (feet)
Minimum Diameter (inches)									
5' x 10' x 5'	4	3	3	4	3	2	3	2	4
9' x 12' x 5'	4	3	3	4	3	2	3½	2	4
12' x 16' x 5'	4½	3½	4	4	3½	2	4	2½	4
14' x 20' x 5'	4½	3½	4	4	3½	2½	4½	2½	4

<sup>a</sup> The maximum post spacing for pou kihī and pou kaha is five feet.

<sup>b</sup> The maximum post spacing for pou hana and pouomanu is twelve feet.



**Table X402.2(b)**  
**Foundation Design for Hale Ku'ai**

Size (W x L x H)	Foundation Type		
	Kahua Diameter x Height	Pa Pohaku Width x Height x Length	Pou Kanu Diameter x Depth
5' x 10' x 5'	3'0"φ x 24"H	2'6"W x 2'0"H x 4'0"L	30"φ x 2'6"D
9' x 12' x 5'	3'4"φ x 24"H	2'6"W x 2'0"H x 4'0"L	30"φ x 2'6"D
12' x 16' x 5'	3'6"φ x 24"H	2'6"W x 2'8"H x 4'0"L	30"φ x 2'8"D
14' x 20' x 5'	3'8"φ x 24"H	2'6"W x 2'8"H x 4'0"L	30"φ x 2'9"D

**402.3 Hale Noa.** Hale Noa shall have at least two openings. One opening shall be at least 3 feet wide and 5 feet high, and the other opening shall be at least 2 feet wide and 3 feet high. Hale Noa shall be designed in accordance with the following schematics and illustrations. Structural components for Hale Noa shall meet the size and spacing requirements in Table X402.3(a). Foundations for Hale Noa shall be designed in accordance with Table X402.3(b).

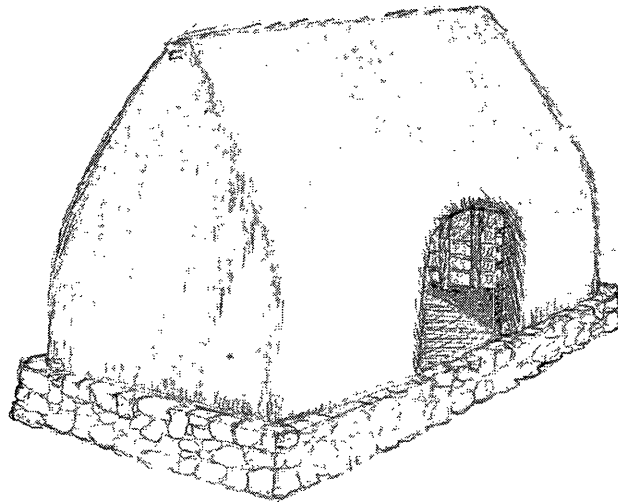

**HALE NOA**

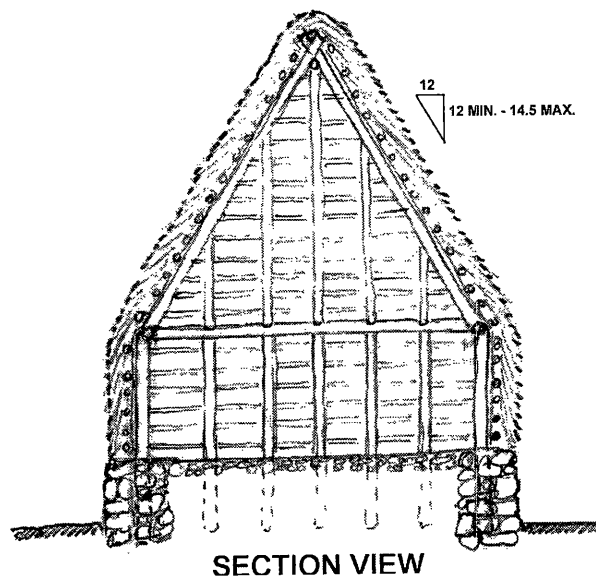

## FRAMING SCHEMATIC

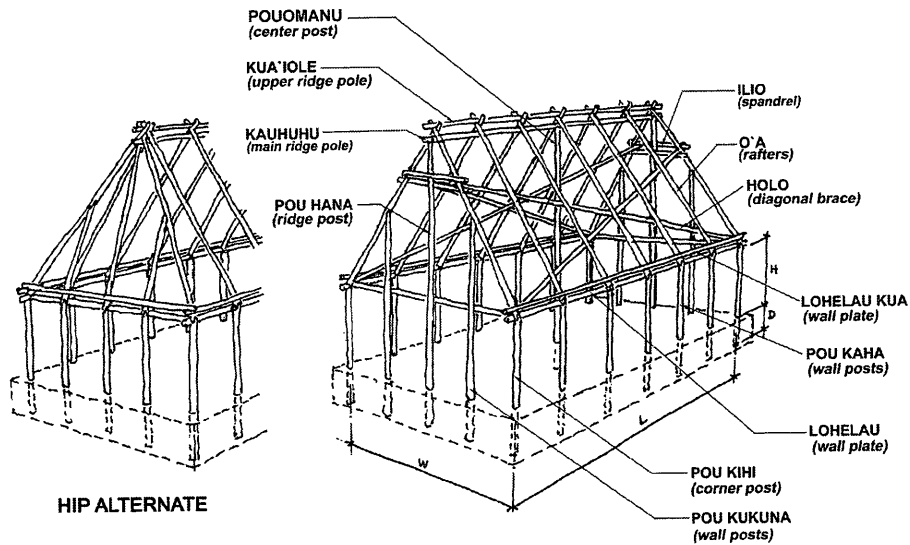

**Table X402.3(a)**

**Size and Spacing Requirements for Structural Components used in Hale Noa**

Size W x L x H	<i>Pou Kihl</i>	<i>Pou Kukuna &amp; Pou Kaha</i>	<i>Pou Hana</i>	<i>Pouomanu</i>	<i>O'a</i>	<i>Kuaiole &amp; Holo</i>	<i>Kauhuhu</i>	<i>Lohelau</i>	Maximum post spacing (feet)	Maximum rafter spacing (feet)
	Minimum Diameter (inches)									
9' x 12' x 7'	3½	3	4	3	3	2½	3½	2½	6	4
12' x 20' x 7'	4	4½	4	3	3½	2½	3½	2½	6	4
4' x 24' x 7'	5½	4½	4	3	3½	2½	3½	3	6	4

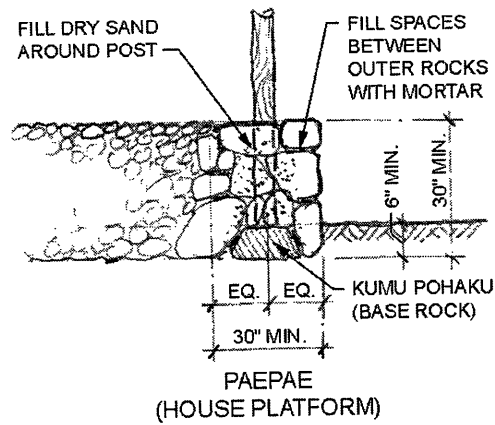

**402.4 Hale Wa'a.** Hale Wa'a shall be designed in accordance with the following schematics and illustrations. Structural components for Hale Wa'a shall meet the size and spacing requirements in Table X402.4.

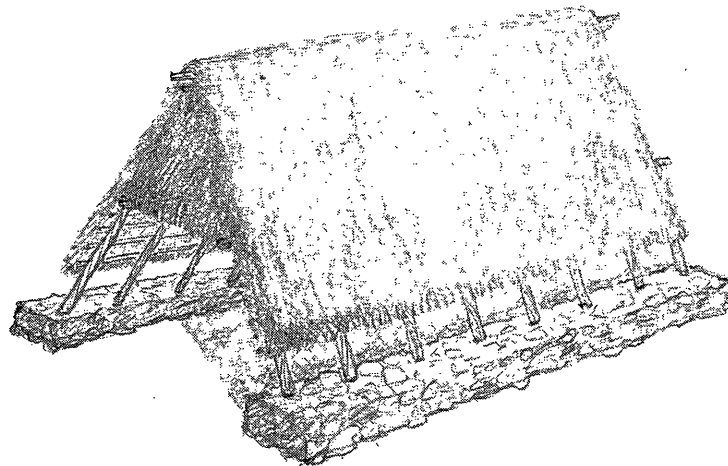

***HALE WA'A***

## FRAMING SCHEMATIC

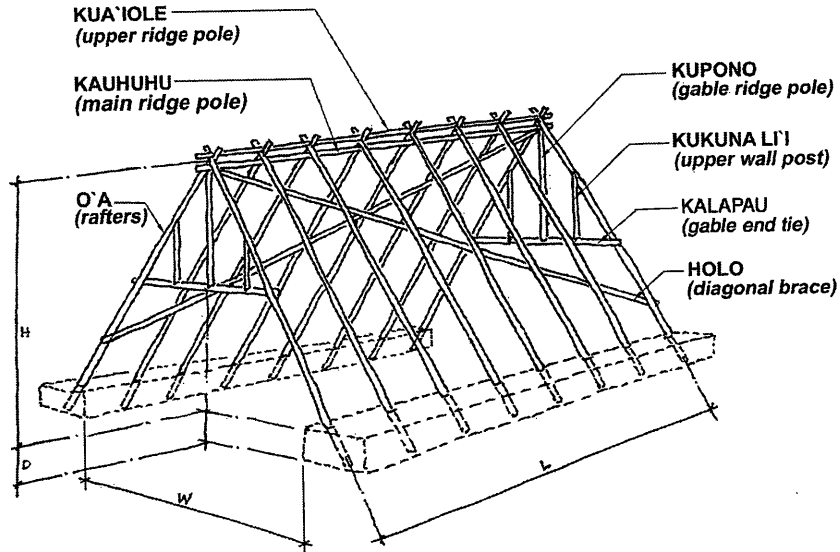

**Table X402.4**  
**Size and Spacing Requirements for Structural Components used in Hale *Wa'a***

Size (W x L)	<i>O'a</i>	<i>Kuaiole</i> & <i>Holo</i>	<i>Kauhuhu</i>	Spacing between Rafters	Minimum ridge Height (H)
20' x 60'	4"	3"	4"	4' to 5'	22½'
25' x 60'	5"	3"	4"	4' to 5'	27½'
30' X 60'	5½"	3"	4"	4' to 5'	27½'

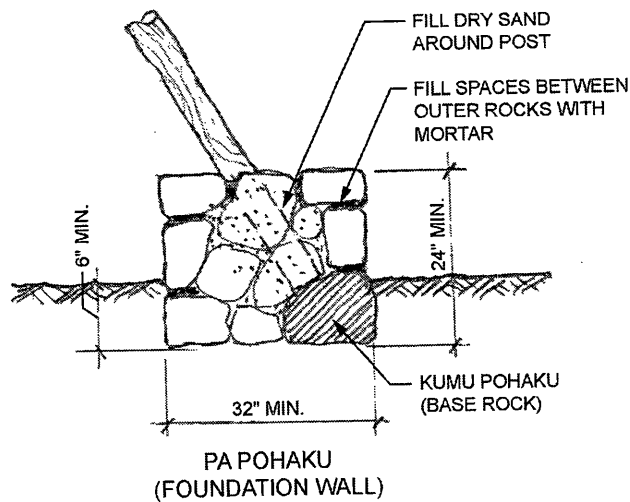

**Section 5A-3-27. Appendix Y; Tiny Houses.**

Appendix Y is added to read as follows:

**“APPENDIX Y  
TINY HOUSES**

**SECTION Y101  
GENERAL**

**Y101.1 Scope.** This appendix shall be applicable to tiny houses used as single dwelling units and tiny houses that contain a loft. Tiny houses shall comply with the International Residential Code except as otherwise stated in this appendix.

**Y101.1.1 Limitations.** Tiny houses shall not contain more than one loft, or loft space. Tiny houses that contain a loft may not be used for any purpose other than as a detached single-family dwelling.

**SECTION Y102  
DEFINITIONS**

**AV102.1 General.** The following words and terms shall, for the purposes of this appendix, have the meanings shown herein. Refer to Chapter 2 of the International Residential Code for general definitions.

**EGRESS ROOF ACCESS WINDOW.** A skylight or roof window designed and installed to satisfy the emergency escape and rescue opening requirements in Section R310.

**LANDING PLATFORM.** A landing measuring two treads deep and two risers tall, provided as the top step of a stairway accessing a loft.

**LOFT.** Any floor level located above the main floor and open to it on at least one side, with a ceiling height less than 6 feet 8 inches (2032 mm), complying with the area, access, and guard requirements of Section AV105, and used as a living or sleeping space.

**TINY HOUSE.** A dwelling which is 500 square feet (37m<sup>2</sup>) or less in floor area excluding lofts. The maximum total floor area of 500 square feet shall mean the sum of the horizontal areas of each floor of a building measured from the exterior faces of the exterior walls. The total floor area shall include enclosed attached accessory structures such as garages or storage areas. Unenclosed attached structures such as carports, breezeways, lanais, or porches shall be excluded.

### **SECTION Y103 FOUNDATIONS**

**Y103.1 General.** All exterior walls shall be permanently supported on continuous solid or fully grouted masonry or concrete footings, crushed stone footings, wood foundations, or other approved structural systems pursuant to Chapter 4 of the International Residential Code, which shall be of sufficient design to accommodate all loads according to Section R301 and to transmit the resulting loads to the soil within the limitations as determined from the character of the soil. Footings shall be supported on undisturbed natural soils or engineered fill.

### **SECTION Y104 CEILING HEIGHT**

**Y104.1 Minimum ceiling height.** Habitable space and hallways in tiny houses shall have a ceiling height not less than 6 feet 8 inches (2032 mm). Bathrooms, toilet rooms, and kitchens shall have a ceiling height not less than 6 feet 4 inches (1930 mm). No obstructions shall extend below these minimum ceiling heights including beams, girders, ducts, lighting, or other obstructions.

**Exception:** Ceiling heights in lofts are permitted to be less than 6 foot 8 inches (2032 mm).

## SECTION Y105 LOFTS

**Y105.1 Minimum loft areas.** Lofts used as a sleeping or living space shall meet the minimum area and dimension requirements of Sections Y105.1.1 through Y105.1.3.

**Y105.1.1 Minimum area.** Lofts shall have a floor area of not less than 35 square feet (3.25 m<sup>2</sup>).

**Y105.1.2 Minimum dimensions.** Lofts shall be not less than 5 feet (1524 mm) in any horizontal dimension.

**Y105.1.3 Height effect on loft area.** Portions of a loft with a sloping ceiling measuring less than 3 feet (914 mm) from the finished floor to the finished ceiling shall not be considered as contributing to the minimum required area for the loft.

**Exception:** Under gable roofs with a minimum slope of 6:12, portions of a loft with a sloping ceiling measuring less than 16 inches (406 mm) from the finished floor to the finished ceiling shall not be considered as contributing to the minimum required area for the loft.

**Y105.1.4 Minimum ceiling height.** Lofts shall have a ceiling height of not less than 3 feet (914.4 mm).

**Y105.1.4.4.1 Undersized lofts.** Lofts having a ceiling height of less than 6 feet (1828.8 mm) for more than 50 percent of the required minimum area shall comply with both of the following:

1. All wall and ceiling of the dwelling unit shall be a minimum 1/2 inch gypsum board or other approved Class A finish, throughout the entire dwelling unit.
2. In addition to the loft smoke alarm required by Y105.4, all other required smoke alarms within the dwelling unit shall be a photoelectric-type complying with R313.

**Y105.1.5 Maximum loft size.** The aggregate floor area of a loft shall not be greater than one-third of the floor area of the room or space in which they are located.

**Y105.2 Loft access.** The access to and primary egress from lofts shall be of any type described in Sections Y105.2.1 through Y105.2.4. All methods of loft access and egress shall be positively anchored to prevent displacement.

**Y105.2.1 Stairways.** Stairways accessing lofts shall comply with this code or with Sections Y105.2.1.1 through Y105.2.1.5

**Y105.2.1.1 Width.** Stairways accessing a loft shall not be less than 17 inches (432 mm) in clear width at all points at or above the permitted handrail height. The minimum width below the handrail shall not be less than 20 inches (508 mm).

**Y105.2.1.2 Headroom.** The headroom in stairways accessing a loft shall not be less than 6 feet 2 inches (1880 mm) measured vertically from the sloped line connecting the tread nosing in the middle of the tread width.

**Exception:** The headroom for landing platforms shall not be less than 4 feet 6 inches (1372 mm).

**Y105.2.1.3 Treads and Risers.** Risers for stairs accessing a loft shall be a minimum of 7 inches (178 mm) and a maximum of 12 inches (305 mm). Tread depth and riser height shall be calculated with the following formulas:

$$\begin{aligned} \text{Tread depth} &= 20 \text{ inches (508 mm) minus } \frac{4}{3} \text{ riser height} \\ &\text{or} \\ \text{Riser height} &= 15 \text{ inches (381 mm) minus } \frac{3}{4} \text{ tread depth} \end{aligned}$$

**Exception:** Landing platforms shall measure two treads deep and two risers tall.

**Y105.2.1.4 Handrails.** Handrails shall comply with Section R311.7.6.

**Y105.2.1.5 Stairway guards.** Guards at open sides of stairways shall comply with Section R312.1.

**Y105.2.2 Ladders.** Ladders accessing lofts shall comply with Sections Y105.2.2.1 and Y105.2.2.2.

**Y105.2.2.1 Size and capacity.** Ladders accessing lofts shall have 12 inches (305 mm) minimum rung width and 10 inches (254 mm) to 14 inch (356 mm) spacing between rungs. Ladders shall be capable of supporting a 300 pound (136 kg) load on any rung. Rung spacing shall be uniform within 3/8-inch (9.5 mm). The maximum height of a ladder shall be 8 feet (2438 mm).

**Y105.2.2 Incline.** Ladders shall be installed at 70 to 80 degrees from horizontal.

**Y105.2.3 Alternating tread devices.** Alternating tread devices accessing lofts 200 square feet or less shall comply with the following provisions:

**Treads of alternation tread devices.** Alternating tread devices shall have a tread depth of not less than 5 inches (127 mm), a projected tread depth of not less than 8-1/2 inches (216 mm), a tread width of not less than 7 inches (178 mm) and a riser height of not more than 9-1/2 inches (241 mm). The tread depth shall be measured horizontally between the vertical planes of the foremost projections of adjacent treads. The riser height shall be measure vertically between leading edges of adjacent treads. The riser height and tread depth provided shall result in an angle of ascent from the horizontal of between 50 and 70 degrees (0.87 and 1.22 rad). The initial tread of the device shall being at the same elevation as the platform, landing or floor surface.

**Handrails of alternating tread devices.** Handrails shall be provided on both sides of alternating tread devices and shall comply with Sections R311.7.8.2 to R311.7.8.6. Handrail height shall be uniform, not less than 30 inches (762 mm) and not more than 34 inches (864 mm).

The clear width at and below the handrails shall be not less than 20 inches (508 mm).

**Y105.2.4 Ships ladders.** Ships ladders accessing lofts 200 square feet or less shall comply with the following provisions:

**Treads of ships ladders.** Treads shall have a depth of not less than 5 inches (127 mm). The tread shall be projected such that the total of the tread depth plus the nosing projection is not less than 8-1/2 inches (216 mm). The riser height shall be not more than 9-1/2 inches (241 mm).

**Handrails of ships ladders.** Handrails shall be provided on both sides of ships ladders and shall comply with Sections R311.7.8.2 to R311.7.8.6. Handrail height shall be uniform, not less than 30 inches (762 mm) and not more than 34 inches (864 mm).

The clear width at and below the handrails shall be not less than 20 inches (508 mm).

**Y105.3 Loft guards.** Loft guards shall be located along the open side(s) of lofts located more than 30 inches (762 mm) above the main floor. Loft guards shall be not less than 36 inches (914 mm) in height or one-half the clear height to the ceiling, whichever is less. Loft guards are not required at the loft accessing means connection to the loft.

**Y105.4 Loft smoke alarms.** Lofts shall be equipped with a minimum of one photoelectric-type smoke alarm complying with R313.

**Y105.5 Loft location.** Lofts shall not be located directly above a permanently installed cooking appliance. Permanently installed cooking appliances shall not be located within 12 inches (304.8 mm) horizontally of a loft open edge, measured to the vertical plane of the loft edge.

## SECTION Y106

### EMERGENCY ESCAPE AND RESCUE OPENINGS

**Y106.1 General.** Tiny houses shall meet the requirements of Section R310 for emergency escape and rescue openings.

**Exception:** Egress roof access windows in lofts used as sleeping rooms shall be deemed to meet the requirements of Section R310 where installed with the bottom of their clear opening no more than 44 inches (1118 mm) above the loft floor provided the egress roof access window complies with the minimum opening area requirements of Section R310.1.”

## Article 4. Building Work Within Special Flood Hazard Areas.

### Section 5A-4-1. General applicability.

- (a) The provisions of this article shall apply to new construction or the renovation and major alteration, addition, or reinstallation of any existing buildings or structures, within a special flood hazard area as identified by chapter 27, Hawai‘i County Code. All construction work shall comply with chapter 16 of the International Building Code, and chapter 27, Floodplain Management.
- (b) The provisions of this article shall not apply to the following:
  - (1) Any building or structure exempted from chapter 27;
  - (2) Any building or structure which has been granted a flood control variance pursuant to article 5, chapter 27; or
  - (3) Any building or structure lawfully existing prior to November 8, 1993, subject to the provisions of chapter 27.

**Section 5A-4-2. Definitions.**

As used in this article, unless it is apparent from the context that a different meaning is intended:

**“Base flood elevation”** means the water surface elevation of the base flood.

**“Flood or flooding”** means:

- (1) A general and temporary condition of partial or complete inundation of normally dry land areas from:
  - (A) The overflow of inland or tidal waters;
  - (B) The unusual and rapid accumulation or runoff of surface waters from any source; or
  - (C) Mudslides (i.e., mudflows) which are approximately caused by flooding as defined in paragraph (1)(B) of this definition and are akin to a river of liquid and flowing mud on the surfaces of normally dry land areas, as when earth is carried by a current of water and deposited along the path of the current; or
- (2) The collapse or subsidence of land along the shore of a lake or other body of water as a result of erosion or undermining caused by waves or currents of water exceeding anticipated cyclical levels or suddenly caused by an unusually high water level in a natural body of water, accompanied by a severe storm, or by an unanticipated force of nature, such as flash flood or an abnormal tidal surge, or by some similarly unusual and unforeseeable event which results in flooding as defined in paragraph (1)(A) of this definition.

**“Special flood hazard area”** means an area having special flood or flood-related erosion hazards, and shown on the Flood Insurance Rate Maps as Zones A, AO, AE, A99, AH, VE, or V.

**“Water-tight”** when referring to construction below the inundation level, means constructed to exclude moisture and withstand the hydraulic pressure resulting from the anticipated depth of inundation.

**Section 5A-4-3. General Requirements.**

Contractor will provide a certified flood zone elevation mark on jobsite for flood zone elevation reference point.

**SECTION 4.** The Hawai‘i County Code 1983 (2016 Edition, as amended) is amended by adding a new chapter, relating to the electrical code, to be designated chapter 5D, and to read as follows:

**“CHAPTER 5D. ELECTRICAL CODE.**

**Article 1. General Provisions.**

**Section 5D-1-1. Title.**

This chapter shall be known as the “electrical code.”

**Section 5D-1-2. Purpose.**

The purpose of this chapter is to reduce the hazards to persons and property from electrical causes by establishing minimum standards for electrical installations in the County.

**Section 5D-1-3. Scope; exceptions.**

This chapter shall apply to electrical installations within the County inland of the shoreline high-water line. Exceptions to these minimum requirements are listed below.

Provisions relating to permitting, enforcement, inspection, and other administrative procedures pertaining to this chapter are contained in chapter 5, the construction administrative code.

This chapter shall not apply to:

- (1) Work or installations not covered by the National Electrical Code, 2017 Edition, as adopted by the State of Hawai‘i;
- (2) Work on buildings or premises owned by or under the direct control of the Federal government;
- (3) Work in public State or County road right-of-ways for utility installations, street lighting, traffic signals, police and fire alarms, bridges, poles, hydraulic flood control structures, and mechanical equipment not specifically regulated in this code where installed:
  - (A) Outside the proposed premises or boundary lines in a subdivision under development; or
  - (B) In an approved subdivision, where the work is in planned or actual roadways or other common infrastructure areas;
- (4) Pursuant to section 448E-13, Hawai‘i Revised Statutes, work by employees of a public utility within the State under a franchise or charter granted by the State which is regulated by the public utilities commission and community antennae television company, while so employed;
- (5) Electrical work related to work regulated by chapter 397, Hawai‘i Revised Statutes, relating to the elevator code, but not including electrical work for the supply of power to the control panels of elevators, dumbwaiters, escalators, moving walks, and manlifts;

- (6) Replacement or repair of devices and apparatus of air conditioning, refrigeration, and heating systems, except electrical work on overcurrent devices that are not physically attached to, or physically mounted on, such systems;
- (7) The construction, alteration or repair of electrical devices commonly used in the home such as portable appliances as defined in section 5-1-5; or
- (8) Agricultural buildings, structures, and appurtenances without electrical power and plumbing systems are exempt from permit and construction code requirements, pursuant to section 46-88, Hawai'i Revised Statutes, except as otherwise provided for in this construction code. No electrical power shall be connected to a building or structure without first obtaining a permit for the electrical work.

#### **Section 5D-1-4. Administrative provisions.**

Provisions relating to permitting, enforcement, inspection, and other administrative procedures pertaining to this chapter are contained in chapter 5, the construction administrative code.

#### **Section 5D-1-5. Existing electrical installations.**

Electrical installations in existence and permitted pursuant to applicable laws and standards in effect when the electrical work thereon was performed, shall not be deemed to be in violation of subsequent changes to applicable laws or standards, provided that such installations shall be subject to the provisions of section 5-2-3 of the construction administrative code.

#### **Section 5D-1-6. Definitions.**

As used in this chapter, unless it is apparent from the context that a different meaning is intended:

“**Article**” means an article of a chapter of the National Electrical Code.

“**Authority having jurisdiction**” means the director of the department of public works, or the director's authorized representative.

“**Building Official**” means the means the director of the department of public works, or the director's authorized representative.

“**Chapter**” means chapter 5D, the electrical code, or chapter 5, the construction administrative code, or both, as the context requires.

“**This code**” means the electrical code, contained in chapter 5D, or the construction administrative code, contained in chapter 5, or both, as the context requires.

“**Dwelling**” Any building that contains one or two dwelling units used, intended, or designed to be built, used, rented, leased, let or hired out to be occupied, or that are occupied for living purposes.

**“Dwelling unit”** A single unit providing complete independent living facilities for one or more persons, including permanent provisions for living, sleeping, eating, cooking, and sanitation.

**“Electrical wiring”** means any conduit, raceway, manhole, handhole, conductor, material, device, fitting, apparatus, appliance, fixture, or equipment constituting a part of or connected to any electrical installation, attached or fastened to any building, structure, or premises and which installation or portion thereof is designed, intended, or used to generate, transmit, transform, or utilize electrical energy within the scope and purpose of the National Electrical Code.

**“Electrical work”** means the installation, alteration, reconstruction, or repair of electrical wiring.

**“Inundation level”** means the maximum expected water level due to flooding by rainfall runoff, wind, waves, and tsunamis as established by the authority having jurisdiction.

**“NEC”** means the National Electrical Code, NFPA 70, 2017 Edition, published by the National Fire Protection Association.

**“NFPA”** means the National Fire Protection Association.

**“Permit”** means a formal authorization issued by the authority having jurisdiction that authorizes performance of specified work, pursuant to the construction code, including the following chapters and all administrative rules adopted pursuant to these chapters:

- (1) 5, the construction administrative code;
- (2) 5A, the building code;
- (3) 5D, the electrical code;
- (4) 5E, the energy conservation code; and
- (5) 5F, the plumbing code.

**“Person”** means any individual, firm, partnership, association, or corporation; or its or their successors or assigns, according to the context thereof.

**“Portable appliances”** means any cord/plug connected device that is readily moveable.

**“Qualified person”** a person holding a valid, unexpired, and unrevoked journey worker electrician, journey worker specialty electrician, supervising electrician, or supervising specialty electrician license under chapter 448E, Hawai'i Revised Statutes, and who has skills and knowledge related to the construction and operation of the electrical equipment and installations and has received safety training to recognize and avoid the hazards involved.

#### **Section 5D-1-7. Compliance required.**

- (a) No person shall perform or cause to be performed any electrical work which does not comply with the provisions of this code or any permit issued pursuant to this code.

- (b) No person shall perform any work covered by this code in violation of the provisions of chapter 448E, Hawai‘i Revised Statutes.
- (c) Any approval or permit issued pursuant to the provisions of this code shall comply with all applicable requirements of this code.
- (d) The granting of a permit, variance, or approval of plans or specifications pursuant to this code does not dispense with the necessity to comply with any applicable law to which a permit holder may also be subject.

**Section 5D-1-8. Conflict.**

- (a) If any provisions of this code conflict with or contravene provisions of the Hawai‘i State Electrical Code or the National Electrical Code that have been incorporated by reference, the provisions of this code shall prevail as to all matters and questions arising out of the subject matter of such provisions.
- (b) In situations where two or more provisions of this code and any applicable law, other than those provided for in subsection (a), cover the same subject matter, the stricter shall be complied with.

**Article 2. Installation Requirements.**

**Section 5D-2-1. National electrical code adopted.**

- (a) The National Electrical Code, 2017 Edition, published by the National Fire Protection Association, One Batterymarch Park, Quincy MA, 02169-7471, including appendices, is incorporated by reference and made a part of this code, subject to any amendments hereinafter set forth in this chapter.
- (b) The scope, technical specifications, and exemptions set forth in the National Electrical Code, 2017 Edition, are hereby adopted as the standard for electrical work covered by this code, provided there are no specific provisions in any other section of this code covering the particular matter.
- (c) A copy of the National Electrical Code, 2017 Edition, shall be available for public inspection at the Hilo and Kailua-Kona offices of the department of public works and at the office of the County clerk.

**Article 3. Electrical Work Within Special Flood Hazard Areas.**

**Section 5D-3-1. General applicability.**

- (a) The provisions of this article shall apply to the: installation of any new electrical system; or the renovation and major alteration, addition, or reinstallation of any existing electrical system, within a special flood hazard area as identified by chapter 27, Hawai‘i County Code. All installations shall comply with chapter 27, Floodplain Management.

- (b) The provisions of this article shall not apply to the following:
- (1) Any electrical system serving a building or structure exempted from chapter 27;
  - (2) Any electrical system serving a building or structure which has been granted a flood control variance pursuant to article 5, chapter 27; or
  - (3) Any electrical system lawfully existing prior to November 8, 1993, subject to the provisions of chapter 27.

### **Section 5D-3-2. Definitions.**

As used in this article, unless it is apparent from the context that a different meaning is intended:

**“Base flood elevation”** means the water surface elevation of the base flood.

**“Flood or flooding”** means:

- (1) A general and temporary condition of partial or complete inundation of normally dry land areas from:
  - (A) The overflow of inland or tidal waters;
  - (B) The unusual and rapid accumulation or runoff of surface waters from any source; or
  - (C) Mudslides (i.e., mudflows) which are approximately caused by flooding as defined in paragraph (1)(B) of this definition and are akin to a river of liquid and flowing mud on the surfaces of normally dry land areas, as when earth is carried by a current of water and deposited along the path of the current; or
- (2) The collapse or subsidence of land along the shore of a lake or other body of water as a result of erosion or undermining caused by waves or currents of water exceeding anticipated cyclical levels or suddenly caused by an unusually high water level in a natural body of water, accompanied by a severe storm, or by an unanticipated force of nature, such as flash flood or an abnormal tidal surge, or by some similarly unusual and unforeseeable event which results in flooding as defined in paragraph (1)(A) of this definition.

**“Special flood hazard area”** means an area having special flood or flood-related erosion hazards, and shown on the Flood Insurance Rate Maps as Zones A, AO, AE, A99, AH, VE, or V.

**“Water-tight”** when referring to construction below the inundation level, means constructed to exclude moisture and withstand the hydraulic pressure resulting from the anticipated depth of inundation.

### **Section 5D-3-3. General Requirements.**

Contractor will provide a certified flood zone elevation mark on jobsite for flood zone elevation reference point.

**Section 5D-3-4. Services.**

- (1) Location. Service equipment shall be located above the inundation level, or where permitted per chapter 27, shall be installed in a water-tight enclosure, room, or vault, and shall be readily accessible in any case.
- (2) Ground Fault Protection. Ground fault protection shall be provided for all grounded wye electrical services.

**Section 5D-3-5. Ground fault protection.**

Approved ground fault circuit protection shall be provided for all feeder and branch circuits below or extending into inundation level.

**Section 5D-3-6. Wiring method and material.**

Equipment such as transformers, fuses, panelboards, switchboards, disconnects, circuit breakers, controllers and other devices used for control, disconnecting means, ground fault protection, or overcurrent protection shall be located above the inundation level, unless made of water-tight construction and permitted per chapter 27.”

**SECTION 5.** The Hawai‘i County Code 1983 (2016 Edition, as amended) is amended by adding a new chapter relating to the energy conservation code, to be designated chapter 5E, and to read as follows:

**“CHAPTER 5E. ENERGY CONSERVATION CODE.**

**Article 1. General Provisions.**

**Section 5E-1-1. Title.**

This chapter shall be known as the “energy conservation code.”

**Section 5E-1-2. Purpose.**

The purpose of this chapter is to promote the design of energy-efficient building envelopes and installation of energy-efficient mechanical, lighting, and power systems by establishing minimum standards that promote modern and up-to-date energy-efficient performance in the construction, alteration, or equipment of buildings or structures in the County of Hawai‘i.

**Section 5E-1-3. Scope; exceptions.**

This chapter sets forth minimum requirements for the design and construction of buildings for the effective use of energy and is intended to provide flexibility to allow the use of innovative approaches and techniques to achieve the effective use of energy. It shall apply to all commercial and residential buildings, building sites, and associated systems and equipment within the County inland of the shoreline high-water line. Exceptions to these minimum requirements are listed below:

This chapter shall not apply to:

- (1) Work or installations not covered by the International Energy Conservation Code, 2015 Edition, as adopted and amended by the State Energy Conservation Code, chapter 3-181.1, Hawai‘i Administrative Rules;
- (2) Work on buildings or premises owned by or under the direct control of the Federal government; or
- (3) Agricultural buildings, structures, and appurtenances without electrical power and plumbing systems are exempt from permit and construction code requirements, pursuant to section 46-88, Hawai‘i Revised Statutes, except as otherwise provided for in this construction code.

**Section 5E-1-4. Administrative provisions.**

Provisions relating to permitting, enforcement, inspection, and other administrative procedures pertaining to this chapter are contained in chapter 5, the construction administrative code.

**Section 5E-1-5. Existing construction and installations.**

Construction and installations in existence and permitted pursuant to applicable laws and standards in effect when the work thereon was performed, shall not be deemed to be in violation of subsequent changes to applicable laws or standards, provided that such installations shall be subject to the provisions of section 5-2-3 of the construction administrative code.

**Section 5E-1-6. Definitions.**

**“Authority having jurisdiction”** means the director of the department of public works, or the director’s authorized representative.

**“Building”** means any structure used or intended for supporting or sheltering any use or occupancy. The term shall include but not be limited to, any structure mounted on wheels such as a trailer, wagon, or vehicle which is parked and stationary for any 24-hour period, and is used for business or living purposes; provided, however, that the term shall not include a push cart or push wagon which is readily movable and which does not exceed 25 square feet in area, nor shall the term include a trailer or vehicle, used exclusively for the purpose of selling any commercial product therefrom, which hold a vehicle license and actually travels on public or private streets.

**“This code”** means the energy conservation code, contained in chapter 5E, or the construction administrative code, contained in chapter 5, or both, as the context requires.

**“Construction code”** means collectively: chapter 5, the construction administrative code; chapter 5A, the building code; chapter 5D, the electrical code; chapter 5E, the energy conservation code; chapter 5F, the plumbing code; and all administrative rules adopted pursuant to these chapters.

**“Dwelling”** means any building that contains one or two dwelling units used, intended, or designed to be built, used, rented, leased, let or hired out to be occupied, or that are occupied for living purposes.

**“Dwelling unit”** means a single unit providing complete independent living facilities for one or more persons, including permanent provisions for living, sleeping, eating, cooking, and sanitation.

**“Engineer”** means a person who is licensed and in good standing as a professional engineer in the State of Hawai‘i.

**“Existing building”** means a building erected prior to the effective date of this chapter, or one for which a legal permit has been issued.

**“ICC”** means the International Code Council.

**“ICC section”** means a section of a chapter of the International Energy Conservation Code.

“**IECC**” means the ICC, International Energy Conservation Code, 2015 edition, as copyrighted by the International Code Council.

“**Permit**” means a formal authorization issued by the authority having jurisdiction that authorizes performance of specified work, pursuant to the following chapters:

- (1) 5, the construction administrative code;
- (2) 5A, the building code;
- (3) 5D, the electrical code;
- (4) 5E, the energy conservation code; and
- (5) 5F, the plumbing code.

“**Person**” means any individual, firm, partnership, association, or corporation, or its or their successors or assigns, according to the context thereof.

“**Section**” means a section of a chapter of the Uniform Plumbing Code.

**Section 5E-1-7. Compliance required.**

- (a) No person shall perform or cause to be performed any work which does not comply with the provisions of this code or any permit issued pursuant to this code.
- (b) No person shall perform any work covered by this code in violation of the provisions of chapter 444, Hawai‘i Revised Statutes.
- (c) Any approval or permit issued pursuant to the provisions of this code shall comply with all applicable requirements of this code.
- (d) The granting of a permit, variance, or approval of plans or specifications pursuant to this code does not dispense with the necessity to comply with any applicable law to which a permit holder may also be subject.

**Section 5E-1-8. Conflict.**

- (a) If any provisions of this code conflict with or contravene provisions of the State Energy Code, found in chapter 3-181, Hawai‘i Administrative Rules, or the International Energy Conservation Code, 2015 Edition, that have been incorporated by reference, the provisions of this code shall prevail as to all matters and questions arising out of the subject matter of such provisions.
- (b) In situations where two or more provisions of this code and any applicable law, other than those provided for in subsection (a), cover the same subject matter, the stricter shall be complied with.

## Article 2. Installation Requirements.

### Section 5E-2-1. International Energy Conservation Code adopted.

- (a) The “International Energy Conservation Code, 2015 Edition” herein referred to as the “International Energy Conservation Code,” as copyrighted and published in 2015 by the International Code Council, Incorporated, 500 New Jersey Avenue, 6th Floor, Washington, DC 20001, is incorporated by reference and made a part of this chapter, subject to the amendments hereinafter set forth in this article. The appendices of the International Energy Conservation Code are not adopted except as provided in this article. A copy of the International Energy Conservation Code shall be available for public inspection at the Hilo and Kailua-Kona offices of the department of public works and at the office of the County clerk.
- (b) This incorporation by reference includes all parts of the International Energy Conservation Code, 2015 Edition, subject to the amendments hereinafter set forth.
- (1) Subsection C101.1 of the International Energy Conservation Code is amended to read as follows:
- “C101.1 Title.** This code shall be known as the Energy Conservation Code and shall be cited as such. “This code” when used within the International Energy Conservation Code as incorporated by reference herein, means the Energy Conservation Code of the County of Hawai‘i.”
- (2) Subsections C101.2 and C101.3 of the International Energy Conservation Code are deleted in their entirety.
- (3) Subsection C101.4 of the International Energy Conservation Code is amended to read as follows:
- “C101.4 Applicability.** Where, in any specific case, different sections of this code or other adopted codes specify different materials, methods of construction or other requirements, the *code official* shall determine which code requirements shall prevail. Where there is a conflict between a general requirement and a specific requirement, the specific requirement shall govern.”
- (4) Subsection C102.1 of the International Energy Conservation Code is amended to read as follows:
- “C102.1 General.** This code is not intended to prevent the use of any material, method of construction, design or insulating system not specifically prescribed herein, provided that such construction, design or insulating system has been *approved* by the *code official* as meeting the intent of this code.

The *code official* may allow alternative energy conservation standards for nonstandard building materials, unique or limitations of design, special methods of construction, and geographical location. The *code official* may require construction plans, research reports, and tests prepared by a registered design professional in order to determine whether to allow such lower standards.”

- (5) Subsection C103.1 of the International Energy Conservation Code is amended to read as follows:

**“C103.1 General.** Construction documents and other supporting data shall be submitted to indicate compliance with this code. The construction documents shall be prepared, designed, approved, and observed by a duly registered licensed professional as required by chapter 464, Hawai‘i Revised Statutes and in accordance with the provisions of chapter 5, Hawai‘i County Code. The licensed professional shall certify via a signed statement on the plans, that the project complies with this code.

Exception:

Any building work that is not required to be prepared, designed, approved, or observed by a licensed professional architect or engineer pursuant to chapter 464, Hawai‘i Revised Statutes, shall be certified by the owner.”

- (6) Subsections C103.3.2 and C103.3.3 of the International Energy Conservation Code are deleted in their entirety.
- (7) Sections C104 and C105 of the International Energy Conservation Code are deleted in their entirety.
- (8) Sections C107 through C109 of the International Energy Conservation Code are deleted in their entirety.
- (9) Subsection C202 of the International Energy Conservation Code is amended by adding the following new definitions to be appropriately inserted and to read as follows:

**“CODE OFFICIAL.** The director of the department of public works of the County of Hawai‘i, the director’s authorized representative, or other designated authority charged with the administration and enforcement of this code.”

**“COOL ROOF.** A cool roof is a roofing system that can deliver high solar reflectance, and high thermal emittance as specified in table C402.3.”

**“HABITABLE SPACE.** A space in a building for living, sleeping, eating or cooking. Bathrooms, toilet rooms, closets, halls, storage or utility spaces and similar areas are not considered habitable spaces.”

**“OCCUPIABLE SPACE.** A room or enclosed space designed for human occupancy in which individuals congregate for amusement, educational or similar purposes or in which occupants are engaged at labor, and which is equipped with means of egress and light and ventilation facilities meeting the requirements of this code.”

**“UNCONDITIONED FLOOR AREA.** The horizontal projection of the floors associated with the unconditioned space.”

**“UNCONDITIONED SPACE.** An area, room or space that is enclosed within the building thermal envelope and is not directly nor indirectly heated or cooled.”

- (10) Subsection C401.2 of the International Energy Conservation Code is amended to read as follows:

**“C401.2 Application.** Commercial buildings shall comply with one of the following:

1. The requirements of ANSI/ASHRAE/IESNA 90.1.
2. The requirements of Sections C402 through C405. In addition, commercial buildings shall comply with Section C406 and tenant spaces shall comply with Section C406.1.1.
3. The requirements of Sections C402.5, C403.2, C404, C405.2, C405.3, C405.5, C405.6 and C407. The building energy cost shall be equal to or less than 85 percent of the standard reference design building.

**Exception:**

For buildings 2,500 square feet or less with 4 tons of cooling or less where it is determined by the code official that the building configuration is similar to that of a residential building, the requirements in Sections R401.2.1 Tropical Zone shall be permitted to be used.”

- (11) Subsection C402.1.1 of the International Energy Conservation Code is amended to read as follows:

**“C402.1.1 Low-energy use buildings.** The following low-energy use buildings, or portions thereof separated from the remainder of the building by *building thermal envelope* assemblies complying with this section, shall be exempt from the *building thermal envelope* provisions of Section C402.

1. Those with a peak design rate of energy usage less than 3.4 Btu/h·ft<sup>2</sup> (10.7 W/m<sup>2</sup>) or 1.0 watt per square foot (10.7 W/m<sup>2</sup>) of floor area for space conditioning purposes.
2. Unconditioned space that does not contain occupiable space and/or habitable space.
3. Greenhouses.
4. Open park pavilions where there is no enclosed space.”

(12) Table C402.1.3 from the International Energy Conservation Code is deleted in its entirety and replaced with the following:

**“TABLE C402.1.3  
OPAQUE THERMAL ENVELOPE INSULATION COMPONENT  
MINIMUM REQUIREMENTS, R-VALUE METHOD<sup>a</sup> - CLIMATE ZONE 1**

<b>CLIMATE ZONE 1</b>		
	<b>All other</b>	<b>Group R</b>
<b>Roofs</b>		
Insulation entirely above roof deck	R-10ci	R-12.5ci
Metal buildings <sup>a, b</sup>	R-30 or R-19 with cool roof <sup>c</sup>	R-30 or R-19 with cool roof <sup>c</sup>
Attic and other	R-30 or R-19 with cool roof <sup>c</sup>	R-30 or R-19 with cool roof <sup>c</sup>
<b>Walls, above grade</b>		
Mass	R-5.7ci <sup>d</sup>	R-5.7ci <sup>d</sup>
Metal building	R-13 + R-6.5ci	R-13 + R-6.5ci
Metal framed	R-13 + R-5ci	R-13 + R-5ci
Wood framed and other	R-13 + R-3.8ci or R-20	R-13 + R-3.8ci or R-20
<b>Walls, below grade</b>		
Below-grade wall	NR	NR
<b>Floors</b>		
Mass	NR	NR
Joist/framing	NR	NR

<b>Slab-on-grade floors</b>		
Unheated slabs	NR	NR
Heated slabs	R-7.5 for 12" below	R-7.5 for 12" below
<b>Opaque doors</b>		
Nonswinging	R-4.75	R-4.75

For SI: 1 inch = 25.4 mm, 1 pound per square foot = 4.88 kg/m<sup>2</sup>, 1 pound per cubic foot = 16 kg/m<sup>3</sup>.

ci = Continuous insulation, NR = No requirement, LS = Liner system.

- a. Assembly descriptions can be found in ANSI/ASHRAE/IESNA Appendix A.
- b. Where using *R*-value compliance method, a thermal spacer block shall be provided, otherwise use the *U*-factor compliance method in Table C402.1.4.
- c. Cool roof is defined as a roof with three-year aged solar reflectance of 0.55 and 3-year aged thermal emittance of 0.75 or 3-year aged solar reflectance index of 64.
- d. R-5.7ci is allowed to be substituted with concrete block walls complying with ASTM C 90, ungrouted or partially grouted at 32 inches or less on center vertically and 48 inches or less on center horizontally, with ungrouted cores filled with materials having maximum thermal conductivity of 0.44 Btu-in/h-ft<sup>2</sup> °F. See Section C402.2.3."

- (13) Subsection C402.2.3 of the International Energy Conservation Code is amended to read as follows:

**“C402.2.3 Thermal resistance of above-grade walls.** The minimum thermal resistance (*R*-value) of materials installed in the wall cavity between framing members and continuously on the walls shall be as specified in Table C402.1.3, based on framing type and construction materials used in the wall assembly.

**Exceptions:**

Continuous insulation for wood, metal framed, and mass walls are not required when at least one of the following conditions is met:

1. Walls have a covering with a reflectance of  $\geq 0.64$ .
2. Walls have overhangs with a projection factor equal to or greater than 0.3. The projection factor is the horizontal distance from the surface of the wall to the farthest most point of the overhang divided by the vertical distance from the first floor level to the bottom most point of the overhang.
3. Concrete, CMU, and similar mass walls are 6 inches or greater in thickness.

The *R*-value of integral insulation installed in concrete masonry units shall not be used in determining compliance with Table C402.1.3.

“Mass walls” shall include walls:

1. Weighing not less than 35 psf (170 kg/m<sup>2</sup>) of wall surface area.

2. Weighing not less than 25 psf (120 kg/m<sup>2</sup>) of wall surface area where the material weight is not more than 120 pcf (1900 kg/m<sup>3</sup>).
3. Having a heat capacity exceeding 7 Btu/ft<sup>2</sup> · °F (144 kJ/m<sup>2</sup> · K).
4. Having a heat capacity exceeding 5 Btu/ft<sup>2</sup> · °F (103 kJ/m<sup>2</sup> · K), where the material weight is not more than 120 pcf (1900 kg/m<sup>3</sup>)."

(14) Table C402.4 from the International Energy Conservation Code is deleted in its entirety and replaced with the following:

**“TABLE C402.4  
BUILDING ENVELOPE FENESTRATION  
MAXIMUM U-FACTOR AND SHGC REQUIREMENTS -  
CLIMATE ZONE 1**

CLIMATE ZONE		1	
<b>Vertical fenestration</b>			
<b>U-factor</b>			
Fixed fenestration		0.50	
Operable fenestration		0.65	
Entrance doors		1.10	
<b>SHGC<sup>b</sup></b>			
Orientation <sup>a</sup>		SEW	N
PF < 0.2		0.25	0.33
0.2 ≤ PF < 0.5		0.30	0.37
PF ≥ 0.5		0.40	0.40
<b>Skylights</b>			
U-factor		0.75	
SHGC		0.35	

NR = No requirement, PF = Projection factor.

- a. "N" indicates vertical fenestration oriented within 45 degrees of true north. "SEW" indicates orientations other than "N." For buildings in the southern hemisphere, reverse south and north.
- b. Exception: Jalousie windows are exempt from SHGC requirements."

- (15) A new subsection C402.4.3.5 is added to the International Energy Conservation Code to read as follows:

**"C402.4.3.5 Area-weighted SHGC.** In commercial buildings, an area-weighted average of fenestration products shall be permitted to satisfy SHGC requirements.

**Exception:** Jalousie windows are exempt from SHGC requirements."

- (16) Subsection C402.5 of the International Energy Conservation Code is amended to read as follows:

**"C402.5 Air leakage-thermal envelope (Mandatory).** The *thermal envelope* of buildings shall comply with Sections C402.5.1 through C402.5.8, or the building *thermal envelope* shall be tested in accordance with ASTM E 779 at a pressure differential of 0.3 inch water gauge (75 Pa) and deemed to comply with the provisions of this section when the tested air leakage rate of the building thermal envelope is not greater than 0.40 cfm/ft<sup>2</sup> (0.2 L/s · m<sup>2</sup>). Where compliance is based on such testing, the building shall also comply with Sections C402.5.5, C402.5.6 and C402.5.7."

- (17) A new subsection C403.2.4.2.4 is added to the International Energy Conservation Code to read as follows:

**"C403.2.4.2.4 Door switches.** Opaque and glass doors opening to the outdoors in hotel and motel sleeping units, guest suites, and time-share condominiums, shall be provided with controls that disable the mechanical cooling or reset the cooling setpoint to 90° F or greater within five minutes of the door opening. Mechanical cooling may remain enabled if the outdoor air temperature is below the space temperature."

- (18) Subsection C405.2 of the International Energy Conservation Code is amended to read as follows:

**"C405.2 Lighting controls (Mandatory).** Lighting systems shall be provided with controls as specified in Sections C405.2.1, C405.2.2, C405.2.3, C405.2.4 and C405.2.5.

**Exceptions:** Lighting controls are not required for the following:

1. Areas designated as security or emergency areas that are required to be continuously lighted.

2. Interior exit stairways, interior exit ramps and exit passageways.
3. Emergency egress lighting that is normally off.
4. Spaces where the designed lighting power densities are less than 70% of the lighting power densities specified in Table C405.4.2(1) and Table C405.4.2(2).”

- (19) Subsection C405.2.4 of the International Energy Conservation Code is amended to read as follows:

**“C405.2.4 Specific application controls.** Specific application controls shall be provided for the following:

1. Display and accent light shall be controlled by a dedicated control that is independent of the controls for other lighting within the room or space.
2. Lighting in cases used for display case purposes shall be controlled by a dedicated control that is independent of the controls for other lighting within the room or space.
3. Hotel and motel sleeping units, guest suites, and time-share condominiums shall have a master control device that is capable of automatically switching off all installed luminaires and switched receptacles within 20 minutes after all occupants leave the room.

**Exception:** Lighting and switched receptacles controlled by captive key systems.

4. Supplemental task lighting, including permanently installed under-shelf or under-cabinet lighting, shall have a control device integral to the luminaires or be controlled by a wall-mounted control device provided that the control device is readily accessible.
5. Lighting for nonvisual applications, such as plant growth and food warming, shall be controlled by a dedicated control that is independent of the controls for other lighting within the room or space.
6. Lighting equipment that is for sale or for demonstrations in lighting education shall be controlled by a dedicated control that is independent of the controls for other lighting within the room or space.”

- (20) A new subsection C405.10 is added to the International Energy Conservation Code to read as follows:

**“C405.10 Sub-metering (Mandatory).** In new buildings with tenants, metering shall be collected for the entire building and individually for each tenant occupying 1,000 ft<sup>2</sup> (total enclosed and unenclosed) (93 m<sup>3</sup>) or more. Tenants shall have access to data

collected for their space. A tenant is defined as “one who rents or leases from a landlord.”

- (21) Subsection C406.3 of the International Energy Conservation Code is amended to read as follows:

**“C406.3 Reduced lighting power density.** The total interior lighting power (watts) of the building shall be determined by using 80 percent of the lighting power values specified in Table C405.4.2(1) times the floor area for the building types, or by using 80 percent of the interior lighting power allowance calculated by the Space-by-Space Method in Section C405.4.2.”

- (22) Subsection C408.2 of the International Energy Conservation Code is amended to read as follows:

**“C408.2 Mechanical systems and service water-heating systems commissioning and completion requirements.** The *registered design professional* or *approved agency* shall provide evidence of mechanical systems *commissioning* and completion in accordance with the provisions of this section to the owner or owner’s authorized agent.

*Construction document* notes shall clearly indicate provisions for *commissioning* and completion requirements in accordance with this section and are permitted to refer to specifications for further requirements. Copies of all documentation shall be given to the owner or owner’s authorized agent and made available to the *code official* upon request in accordance with Sections C408.2.4 and C408.2.5.

**Exceptions:** The following systems are exempt:

1. Mechanical systems and service water heater systems in buildings where the total mechanical equipment capacity is less than 480,000 Btu/h (140.7 kW) cooling capacity and 600,000 Btu/h (175.8 kW) combined service water-heating and space-heating capacity.
2. Systems included in Section C403.3 that serve individual *dwelling units* and *sleeping units*.”

- (23) Subsection C408.2.4.1 of the International Energy Conservation Code is deleted in its entirety.

- (24) Subsection C408.3.1 of the International Energy Conservation Code is amended to read as follows:

**“C408.3.1 Functional Testing.** The *registered design professional* shall provide to the owner or owner’s representative evidence that the lighting control systems have been tested to ensure that control hardware and software are calibrated, adjusted, programmed and in proper working condition in accordance with the *construction documents* and manufacturer’s instructions. Functional testing shall be in accordance with Sections C408.3.1.1 and C408.3.1.2 for the applicable control type.”

- (25) Subsection C501.4 of the International Energy Conservation Code is amended to read as follows:

**“C501.4 Compliance.** *Alterations, repairs, additions* and changes of occupancy to, or relocation of, existing buildings and structures shall comply with the provisions and regulations for *alterations, repairs, additions* and changes of occupancy or relocation, as adopted by the building official.”

- (26) Subsection C503.3.1 of the International Energy Conservation Code is amended to read as follows:

**“C503.3.1 Roof replacement.** *Roof replacement* of uninsulated roofs shall include at least one of the following:

1. Energy Star compliant roof covering;
2. Radiant barrier; or
3. Attic ventilation via solar attic fan(s), or ridge ventilation, or gable ventilation.”

- (27) Subsection R101.1 of the International Energy Conservation Code is amended to read as follows:

**“R101.1 Title.** This code shall be known as the Energy Conservation Code, and shall be cited as such. “This code” when used within the International Energy Conservation Code as incorporated by reference herein, means the Energy Conservation Code of Hawai‘i County.”

- (28) Subsection R103.1 of the International Energy Conservation Code is amended to read as follows:

**“R103.1 General.** Construction documents and other supporting data shall be submitted to indicate compliance with this code. The construction documents shall be prepared, designed, approved, and observed by a duly registered licensed professional as required by chapter 464, Hawai‘i Revised Statutes and in accordance with the provisions of chapter 5, Hawai‘i County Code. The licensed professional shall certify via a signed statement on the plans, that the project complies with this code.

**Exception:** Any building, electrical, or plumbing work that is not required to be prepared, designed, approved, or observed by a licensed professional architect or engineer pursuant to chapter 464, Hawai‘i Revised Statutes, shall be certified by the owner.”

- (29) Subsections R103.3.2 and R103.3.3 of the International Energy Conservation Code are deleted in their entirety.
- (30) Subsection R202 of the International Energy Conservation Code is amended by adding the following new definitions to be appropriately inserted and to read as follows:

**“CODE OFFICIAL.** The director of the department of public works of the County of Hawai‘i, the director’s authorized representative, or other designated authority charged with the administration and enforcement of this code.”

**“COOL ROOF.** A cool roof is a roofing system that can deliver high solar reflectance, and high thermal emittance as specified in table C402.3.”

**“HABITABLE SPACE.** A space in a building for living, sleeping, eating or cooking. Bathrooms, toilet rooms, closets, halls, storage or utility spaces, garages or carports, and similar areas are not considered habitable spaces.”

**“OCCUPIABLE SPACE.** A room or enclosed space designed for human occupancy in which individuals congregate for amusement, educational or similar purposes or in which occupants are engaged at labor, and which is equipped with means of egress and light and ventilation facilities meeting the requirements of this code.”

**“UNCONDITIONED FLOOR AREA.** The horizontal projection of the floors associated with the unconditioned space.”

**“UNCONDITIONED SPACE.** An area, room or space that is enclosed within the building thermal envelope and is not directly nor indirectly heated or cooled.”

- (31) Subsection R401.2 of the International Energy Conservation Code is amended to read as follows:

**“R401.2 Compliance.** Projects shall comply with one of the following:

1. Sections R401.3 through R404.
2. Section R405 and the provisions of Sections R401 through R404 labeled “Mandatory.”
3. An energy rating index (ERI) approach in Section R406.
4. The tropical zone requirements in Section R401.2.1 and R401.3.”

- (32) Subsection R401.2.1 of the International Energy Conservation Code is amended to read as follows:

**“R401.2.1 Tropical zone.** *Residential buildings* in the tropical zone at elevations below 5,000 feet above sea level shall be deemed to comply with this chapter where the following conditions are met:

1. Not more than one-half of the dwelling unit area is air conditioned.
2. The dwelling unit is not heated.
3. Solar, wind, or other renewable energy source supplies not less than 90 percent of the energy for service water heating.

**Exception:** A water heating device as approved via Solar Hot Water Heater Variance by the Department of Business, Economic Development & Tourism, Hawai‘i State Energy Office.

4. Glazing in dwelling units shall have a maximum *solar heat gain coefficient* as specified in Table R401.2.1.

Table 401.2.1

Vertical Fenestration Glazing SHGC Requirements

Projection Factor (pf) of overhang from base of average vertical fenestration glazing sill*	SHGC
< 0.30	0.25
0.30 – 0.49	0.40
≥ 0.50	N/A

\*Exceptions:

- a. North-facing vertical fenestration glazing with pf > 0.20 are exempt from SHGC requirements. Overhangs shall extend 2 feet on each side of vertical fenestration glazing or to nearest wall, whichever is less.
- b. Jalousie windows are exempt from SHGC requirements.
- c. "N" indicates vertical fenestration oriented within 45 degrees of true north. "SEW" indicates orientations other than "N".

5. Skylights in dwelling units shall have a maximum U-factor as specified in Table R402.1.2.
6. Permanently installed lighting is in accordance with Section R404.
7. The roof/ceiling complies with one of the following options:
  - A. Comply with one of the roof surface options in Table C402.3 and install R-13 insulation or greater.
  - B. Install R-19 insulation or greater.

If present, attics above the insulation are vented and attics below the insulation are unvented.

**Exception:** The roof/ceiling assembly is permitted to comply with Section R407.

8. Operable fenestration provides ventilation area equal to not less than 14 percent of the floor area in each habitable room. Alternatively, equivalent ventilation of 2 air changes per hour is provided by a mechanical ventilation fan.
9. Bedrooms with exterior walls facing two different directions have operable fenestration on exterior walls facing two different directions.
10. Interior doors to bedrooms are capable of being secured in the open position.
11. A ceiling fan, ceiling fan rough-in, or whole-house fan is provided for bedrooms and the largest space that is not used as a bedroom.

12. Walls, floors, and ceilings separating air conditioned spaces from non-air conditioned spaces shall be constructed to limit air leakage in accordance with the requirements in Table R402.4.1.1. Blower door test is optional.”

- (33) Subsection R401.3 of the International Energy Conservation Code is amended to read as follows:

**“R401.3 Certificate (Mandatory).** A permanent certificate shall be completed by the builder or registered design professional and posted on a wall in the space where the furnace is located, a utility room or an approved location inside the building. Where located on an electrical panel, the certificate shall not cover or obstruct the visibility of the circuit directory label, service disconnect label or other required labels. The certificate shall:

1. List the predominant *R*-values of insulation installed in or on ceiling/roof, walls, and ducts outside conditioned spaces; *U*-factors for fenestration and the solar heat gain coefficient (SHGC) of fenestration, and the results from any required duct system and building envelope air leakage testing done on the building. Where there is more than one value for each component, the certificate shall list the value covering the largest area.
2. List the types and efficiencies of heating, cooling and service water heating equipment. Where a gas-fired unvented room heater, electric furnace or baseboard electric heater is installed in the residence, the certificate shall list “gas-fired unvented room heater,” “electric furnace” or “baseboard electric heater,” as appropriate. An efficiency shall not be *listed* for gas-fired unvented room heaters, electric furnaces or electric baseboard heaters.
3. Indicate which areas have been designed and constructed as conditioned or unconditioned space.
4. Include the following text: “The addition of mechanical cooling or heating to an unconditioned space requires a permit. The addition of cooling without proper design and construction can have adverse health, safety, and conservation consequences.””

- (34) Subsection R402.1 of the International Energy Conservation Code is amended to read as follows:

**“R402.1 General (Prescriptive).**

The *building thermal envelope* shall meet the requirements of Sections R402.1.1 through R402.1.5.

**Exception:** The following low-energy buildings, or portions thereof, separated from the remainder of the building by *building thermal envelope* assemblies complying with this section shall be exempt from the *building thermal envelope* provisions of Section R402.

1. Those with a peak design rate of energy usage less than 3.4 Btu/h · ft<sup>2</sup> (10.7 W/m<sup>2</sup>) or 1.0 watt/ft<sup>2</sup> (10.7 W/m<sup>2</sup>) of floor area for space-conditioning purposes.
2. Unconditioned space that does not contain habitable space.
3. Unconditioned dwellings with enclosed habitable areas less than 1,100 square feet.”
4. Dwellings with permitted, off-grid, self supplying photovoltaic with battery back up.”

(35) TABLE R402.1.2 of the International Energy Conservation Code is deleted in its entirety and replaced with the following:

**“TABLE R402.1.2  
INSULATION AND FENESTRATION REQUIREMENTS BY COMPONENT<sup>a</sup>**

CLIMATE ZONE	FENESTRATION U-FACTOR <sup>b</sup>	SKYLIGHT U-FACTOR <sup>b</sup>	GLAZED FENESTRATION SHGC <sup>b, c, g</sup>	CEILING R-VALUE <sup>d</sup>	WOOD FRAME WALL R-VALUE <sup>d</sup>	MASS WALL R-VALUE <sup>e, f</sup>	FLOOR R-VALUE	BASEMENT WALL R-VALUE	SLAB R-VALUE & DEPTH	CRAWL SPACE WALL R-VALUE
1	NR	0.75	0.25	30	13	3/4	0	0	0	0

For SI: 1 foot = 304.8 mm

- a. R-values are minimums. U-factors and SHGC are maximums. When insulation is installed in a cavity which is less than the label or design thickness of the insulation, the installed R-value of the insulation shall not be less than the R-value specified in the table.
- b. The fenestration U-factor column excludes skylights. The SHGC column applies to all glazed fenestration. Exception: Skylights may be excluded from glazed fenestration SHGC requirements in climate zones 1 through 3 where the SHGC for such skylights does not exceed 0.30.
- c. Exception: If fenestration have overhangs with projection factors, the maximum solar heat gain coefficient shall be as specified in Table R401.2.1.
- d. R402.1.2 and R402.2 allow use of R407.
- e. The second R-value applies when more than half the insulation is on the interior of the mass wall.
- f. Exception: R-value for mass walls are not required if: mass walls have a covering with reflectance of  $\geq 0.64$ ; mass walls have overhangs with a projection factor equal to or greater than 0.3. CMU or similar mass walls are 6 inches or greater in thickness.
- g. Exception: Jalousie windows are exempt from SHGC requirements.”

(36) Subsection R402.1.2 of the International Energy Conservation Code is amended to read as follows:

**“R402.1.2 Insulation and fenestration criteria (Prescriptive).**

The *building thermal envelope* shall meet the requirements of Table R402.1.2,

**Exception:** Insulation values of above-grade walls and ceilings shall be permitted to comply with Section R407.”

- (37) Subsection R402.2 of the International Energy Conservation Code is amended to read as follows:

**“R402.2 Specific insulation requirements (Prescriptive).**

In addition to the requirements of Section R402.1, insulation shall meet the specific requirements of Sections R402.2.1 through R402.2.13.

**Exception:** Above-grade walls and ceilings shall be permitted to comply with Section R407.”

- (38) Subsection R402.2.5 of the International Energy Conservation Code is amended to read as follows:

**“R402.2.5 Mass walls.** Mass walls for the purposes of this chapter shall be considered above-grade walls of concrete block, concrete, insulated concrete form (ICF), masonry cavity, brick (other than brick veneer), earth (adobe, compressed earth block, rammed earth) and solid timber/logs, or any other walls having a heat capacity greater than or equal to 6 Btu/ft<sup>2</sup> x °F (123 kJ/m<sup>2</sup> x K).

**Exception:** Insulation or *R*-value for mass walls, indicated in Table R402.1.2, is not required when at least one of the following conditions is met:

1. Walls have a covering with a reflectance of  $\geq 0.64$ .
2. Walls have overhangs with a projection factor equal to or greater than 0.3. The projection factor is the horizontal distance from the surface of the wall to the farthest most point of the overhang divided by the vertical distance from the first floor level to the bottom most point of the overhang.
3. Concrete, CMU, and similar mass walls are 6 inches or greater in thickness.”

- (39) Subsection R402.3.2 of the International Energy Conservation Code is amended to read as follows:

**“R402.3.2 Glazed fenestration SHGC.** Fenestration shall have a maximum solar heat gain coefficient as specified in Table R402.1.2. An area-weighted average of fenestration products more than 50-percent glazed shall be permitted to satisfy the SHGC requirements.

**Exceptions:**

1. Jalousie windows are exempt from SHGC requirements.
2. If fenestrations have overhangs with projection factors, the maximum solar heat gain coefficient shall be as specified in Table R401.2.1.

*Dynamic glazing* shall be permitted to satisfy the SHGC requirements of Table R402.1.2 provided the ratio of the higher to lower labeled SHGC is greater than or equal to 2.4, and the *dynamic glazing* is automatically controlled to modulate the amount of solar gain into the space in multiple steps. *Dynamic glazing* shall be considered separately from other fenestration, and area-weighted averaging with other fenestration that is not dynamic glazing shall not be permitted.

**Exception:** *Dynamic glazing* is not required to comply with this section when both the lower and higher labeled SHGC already comply with the requirements of Table R402.1.2.”

- (40) Subsection R402.4.1.2 of the International Energy Conservation Code is amended to read as follows:

**“R402.4.1.2 Testing.** The building or dwelling unit may be tested and verified as having an air leakage rate not exceeding five air changes per hour in Climate Zones 1 and 2, and three air changes per hour in Climate Zones 3 through 8. Testing shall be conducted in accordance with ASTM E 779 or ASTM E 1827 and reported at a pressure of 0.2 inch w.g. (50 Pascals). Testing shall be performed at any time after creation of all penetrations of the *building thermal envelope*.

During testing:

1. Exterior windows and doors, fireplace and stove doors shall be closed, but not sealed, beyond the intended weatherstripping or other infiltration control measures.
2. Dampers including exhaust, intake, makeup air, backdraft and flue dampers shall be closed, but not sealed beyond intended infiltration control measures.
3. Interior doors, if installed at the time of the test, shall be open.
4. Exterior doors for continuous ventilation systems and heat recovery ventilators shall be closed and sealed.
5. Heating and cooling systems, if installed at the time of the test, shall be turned off.
6. Supply and return registers, if installed at the time of the test, shall be fully open.”

- (41) A new subsection R403.5.5 is added to the International Energy Conservation Code to read as follows:

**“R403.5.5 Solar water heating.** Solar water heating systems are required for new single-family residential construction pursuant to section 196-6.5, Hawai‘i Revised Statutes.

**Exception:** A water heating device as approved via Solar Hot Water Heater Variance by the Department of Business, Economic Development & Tourism, Hawai'i State Energy Office."

(42) A new subsection R404.2 is added to the International Energy Conservation Code to read as follows:

**"R404.2 Ceiling Fans.** A ceiling fan, ceiling fan rough-in, or whole house fan may be provided for bedrooms and the largest habitable space that is not used as a bedroom."

(43) A new subsection R404.3 is added to the International Energy Conservation Code to read as follows:

**"R404.3 Electrical vehicle charger power.** An electrical rough-in of a 30 amp circuit for future electrical vehicle charger may be installed in garage/carport area."

(44) TABLE 405.5.2(1) of the International Energy Conservation Code is amended to read as follows:

**"TABLE R405.5.2(1)  
SPECIFICATIONS FOR THE STANDARD REFERENCE AND  
PROPOSED DESIGNS**

<b>BUILDING COMPONENT</b>	<b>STANDARD REFERENCE DESIGN</b>	<b>PROPOSED DESIGN</b>
Above-grade walls	Type: mass wall if proposed wall is mass; otherwise wood frame	As proposed
	Gross area: same as proposed	As proposed
	U-factor: as specified in Table R402.1.4	As proposed
	Solar absorptance = 0.75	As proposed
	Emittance = 0.90	As proposed
Basement and crawl space walls	Type: same as proposed	As proposed
	Gross area: same as proposed	As proposed
	U-factor: from Table R402.1.4, with insulation layer on interior side of walls	As proposed
Above-grade floors	Type: wood frame	As proposed
	Gross area: same as proposed	As proposed
	U-factor: as specified in Table R402.1.4	As proposed
Ceilings	Type: wood frame	As proposed
	Gross area: same as proposed	As proposed
	U-factor: as specified in Table R402.1.4	As proposed

Roofs	Type: composition shingle on wood sheathing	As proposed
	Gross area: same as proposed	As proposed
	Solar absorptance = 0.75	As proposed
	Emittance = 0.90	As proposed
Attics <sup>i</sup>	Type: vented with aperture = 1 ft <sup>2</sup> per 300 ft <sup>2</sup> ceiling area	As proposed
Foundations	Type: same as proposed	As proposed
	Foundation wall area above and below grade and soil characteristics: same as proposed	As proposed
Opaque doors	Area: 40 ft <sup>2</sup>	As proposed
	Orientation: North	As proposed
	U-factor: same as fenestration from Table R402.1.4	As proposed
Vertical fenestration other than opaque doors	Total area <sup>h</sup> = (a) The proposed glazing area, where the proposed glazing area is less than 15 percent of the conditioned floor area (b) 15 percent of the conditioned floor area, where the proposed glazing area is 15 percent or more of the conditioned floor area	As proposed
	Orientation: equally distributed to four cardinal compass orientations (N, E, S & W).	As proposed
	U-factor: as specified in Table R402.1.4	As proposed
	SHGC: as specified in Table R402.1.2 except that for climates with no requirement (NR) SHGC = 0.40 shall be used.	As proposed
	Interior shade fraction: 0.92 - (0.21 × SHGC for the standard reference design)	0.92 - (0.21 × SHGC as proposed)
	External shading: none	As proposed
Skylights	None	As proposed
Thermally isolated sunrooms	None	As proposed

Air exchange rate	<p>Air leakage rate of 5 air changes per hour in climate zones 1 and 2, and 3 air changes per hour in climate zones 3 through 8 at a pressure of 0.2 inches w.g (50 Pa). The mechanical ventilation rate shall be in addition to the air leakage rate and the same as in the proposed design, but no greater than <math>0.01 \times CFA + 7.5 \times (N_{br} + 1)</math></p> <p>where:  <math>CFA</math> = conditioned floor area  <math>N_{br}</math> = number of bedrooms  Energy recovery shall not be assumed for mechanical ventilation.</p>	<p>For residences that are not tested, the same air leakage rate as the standard reference design.</p> <p>For tested residences, the measured air exchange rate<sup>a</sup>.</p> <p>The mechanical ventilation rate<sup>b</sup> shall be in addition to the air leakage rate and shall be as proposed.</p>
Mechanical ventilation	<p>None, except where mechanical ventilation is specified by the proposed design, in which case:</p> <p>Annual vent fan energy use:  <math>\text{kWh/yr} = 0.03942 \times CFA + 29.565 \times (N_{br} + 1)</math></p> <p>where:  <math>CFA</math> = conditioned floor area  <math>N_{br}</math> = number of bedrooms</p>	As proposed
Internal gains	$IGain = 17,900 + 23.8 \times CFA + 4104 \times N_{br}$ (Btu/day per dwelling unit)	Same as standard reference design
Internal mass	An internal mass for furniture and contents of 8 pounds per square foot of floor area	Same as standard reference design, plus any additional mass specifically designed as a thermal storage element <sup>c</sup> but not integral to the building envelope or structure.
Structural mass	For masonry floor slabs, 80 percent of floor area covered by R-2 carpet and pad, and 20 percent of floor directly exposed to room air.	As proposed
	For masonry basement walls, as proposed, but with insulation required by Table R402.1.4 located on the interior side of the walls	As proposed
	For other walls, for ceilings, floors, and interior walls, wood frame construction	As proposed

Heating systems <sup>d, e</sup>	Fuel type: same as proposed design.	As proposed
	Efficiencies: Electric: Air-source heat pump with prevailing federal minimum standards.	As proposed
	Nonelectric furnaces: natural gas furnace with prevailing federal minimum standards.	As proposed
	Nonelectric boilers: natural gas boiler with prevailing federal minimum standards.	As proposed
	Capacity: sized in accordance with Section R403.7.	As proposed
Cooling systems <sup>d, f</sup>	Fuel type: Electric Efficiency: in accordance with prevailing federal minimum standards. Capacity: sized in accordance with Section R403.7.	As proposed As proposed
	Fuel type: same as proposed design Efficiency: in accordance with prevailing federal minimum standards. Use: Same as proposed design	As proposed As proposed $\text{gal/day} = 30 + (10 \times N_{br})$
Service water heating <sup>d, e, f, g</sup>	Duct insulation: From Section R403.2.1  A thermal distribution system efficiency (DSE) of 0.88 shall be applied to both the heating and cooling system efficiencies for all systems other than tested duct systems. For tested duct systems, the leakage rate shall be 4 cfm (113.3 L/min) per 100 ft <sup>2</sup> (9.29 m <sup>2</sup> ) of <i>conditioned floor</i> area at a pressure of differential of 0.1 inches w.g. (25 Pa).	As tested or as specified in Table R405.5.2(2) if not tested. Duct insulation shall be as proposed.
Thermal distribution systems	Type: Manual, cooling temperature setpoint = 75°F; Heating temperature setpoint = 72°F	Same as standard reference

For SI: 1 square foot = 0.93 m<sup>2</sup>, 1 British thermal unit = 1055 J, 1 pound per square foot = 4.88 kg/m<sup>2</sup>, 1 gallon (US) = 3.785 L, °C = (°F-32)/1.8, 1 degree = 0.79 rad.

- a. Where required by the *code official*, testing shall be conducted by an *approved* party. Hourly calculations as specified in the *ASHRAE Handbook of Fundamentals*, or the equivalent shall be used to determine the energy loads resulting from infiltration.

- b. The combined air exchange rate for infiltration and mechanical ventilation shall be determined in accordance with Equation 43 of 2001 ASHRAE *Handbook of Fundamentals*, page 26.24 and the "Whole-house Ventilation" provisions of 2001 ASHRAE *Handbook of Fundamentals*, page 26.19 for intermittent mechanical ventilation.
- c. Thermal storage element shall mean a component not part of the floors, walls or ceilings that is part of a passive solar system, and that provides thermal storage such as enclosed water columns, rock beds, or phase-change containers. A thermal storage element must be in the same room as fenestration that faces within 15 degrees (0.26 rad) of true south, or must be connected to such a room with pipes or ducts that allow the element to be actively charged.
- d. For a proposed design with multiple heating, cooling or water heating systems using different fuel types, the applicable standard reference design system capacities and fuel types shall be weighted in accordance with their respective loads as calculated by accepted engineering practice for each equipment and fuel type present.
- e. For a proposed design without a proposed heating system, a heating system with the prevailing federal minimum efficiency shall be assumed for both the standard reference design and proposed design.
- f. For a proposed design home without a proposed cooling system, an electric air conditioner with the prevailing federal minimum efficiency shall be assumed for both the standard reference design and the proposed design.
- g. For a proposed design with a nonstorage-type water heater, a 40-gallon storage-type water heater with the prevailing federal minimum energy factor for the same fuel as the predominant heating fuel type shall be assumed. For the case of a proposed design without a proposed water heater, a 40-gallon storage-type water heater with the prevailing federal minimum efficiency for the same fuel as the predominant heating fuel type shall be assumed for both the proposed design and standard reference design.
- h. For residences with conditioned basements, R-2 and R-4 residences and townhouses, the following formula shall be used to determine glazing area:  

$$AF = A_s \times FA \times F$$
 where:  
 $AF$  = Total glazing area  
 $A_s$  = Standard reference design total glazing area.  
 $FA$  = (Above-grade thermal boundary gross wall area)/(above-grade boundary wall area + 0.5 × below-grade boundary wall area).  
 $F$  = (Above-grade thermal boundary wall area)/(above-grade thermal boundary wall area + common wall area) or 0.56, whichever is greater.  
 and where:  
 Thermal boundary wall is any wall that separates conditioned space from unconditioned space or ambient conditions.  
 Above-grade thermal boundary wall is any thermal boundary wall component not in contact with soil.  
 Below-grade boundary wall is any thermal boundary wall in soil contact.  
 Common wall area is the area of walls shared with an adjoining dwelling unit.  
 $L$  and  $CFA$  are in the same units.
- i. Unvented Attic Spaces. The attic space shall be permitted to be unvented when the design professional determines it would be beneficial to eliminate ventilation openings to reduce salt-laden air and maintain relative humidity 60 percent or lower to:
- (1) Avoid corrosion to steel components,
  - (2) Avoid moisture condensation in the attic space, or
  - (3) Minimize energy consumption for air conditioning or ventilation by maintaining satisfactory space conditions in both the attic and occupied space below."

- (45) A new section R407 is added to the International Energy Conservation Code to read as follows:

**“SECTION R407  
POINTS OPTION**

**R407.1 General (Prescriptive).** Above-grade walls and roofs are permitted to comply with the points option as an alternative to complying with Sections R401.2.1, R402.1.2 and R402.2.

**R407.2 Requirements.** One or more efficiency measures shall be selected for roof and above-grade wall systems from Table R407.1 that cumulatively equal or exceed 0 (zero) points. As an alternative, above-grade walls and roofs are permitted to comply separately by scoring 0 (zero) or greater.

**TABLE R407.1  
POINTS OPTION**

		<b>Standard Home Points</b>	<b>Tropical Home Points</b>
<b>Wood Framed</b>			
Roof Insulation (Must choose 1)	R-19 Roof Insulation	-1	0
	R-19 Roof Insulation + Cool roof membrane <sup>1</sup> or Radiant Barrier <sup>3</sup>	0	1
	R-19 Roof Insulation + Attic Venting <sup>2</sup>	0	1
	R-30 Roof Insulation	0	1
Wall Insulation (Must choose 1)	R-13 Cavity Wall Insulation	0	1
	R-13 Wall Insulation + high reflectance walls <sup>4</sup>	1	2
	R-13 Wall Insulation + 90% high efficacy lighting and Energy Star Appliances <sup>5</sup>	1	2
	R-13 Wall Insulation + exterior shading wpf=0.3 <sup>6</sup>	1	2
Mechanical / Electrical Systems (Choose ONLY if applies to scope of work)	Ductless Air Conditioner <sup>7</sup>	1	1
	1.071 X Federal Minimum SEER for Air Conditioner	1	1
	1.142 X Federal Minimum SEER for Air Conditioner	2	2
	No air conditioning installed	Not Applicable	2

Must choose if applies to new construction and/or additions (House floor area to be considered as existing dwelling size plus new square footage)	House floor area $\leq$ 1,000 SF	1	1
	House floor area $\geq$ 2,500 SF	-1	-1
	Energy Star Fans <sup>8</sup>	1	1
	Install 1 kW or greater of solar electric	1	1
	Reduce fenestration from 14% to 10%	Not Applicable	-1
<b>Metal Framed</b>			
Wall Insulation (Must choose 1)	R-13 + R 3 Wall Insulation	0	1
	R-13 cavity Wall Insulation + R-0	-1	0
	R-13 Wall Insulation + high reflectance walls <sup>4</sup>	0	1
	R-13 Wall Insulation + 90% high efficacy lighting and Energy Star Appliances <sup>5</sup>	1	2
	R-13 Wall Insulation + exterior shading wpf=0.3 <sup>6</sup>	0	1
Roof Insulation (Must choose 1)	R-30 Roof Insulation	0	1
	R-19 Roof Insulation	-1	0
	R-19 + Cool roof membrane <sup>1</sup> or Radiant Barrier <sup>3</sup>	0	1
	R-19 Roof Insulation + Attic Venting <sup>2</sup>	0	1
Mechanical / Electrical Systems (Choose ONLY if applies to scope of work)	Ductless Air Conditioner <sup>7</sup>	1	1
	1.071 X Federal Minimum SEER for Air Conditioner	1	1
	1.142 X Federal Minimum SEER for Air Conditioner	2	2
	No air conditioning installed	Not Applicable	2
Must choose if applies to new construction and/or additions (house floor area to be considered as existing dwelling size plus new square footage)	House floor area $\leq$ 1,000 SF	1	1
	House floor area $\geq$ 2,500 SF	-1	-1
	Energy Star Fans <sup>7</sup>	1	1
	Install 1 kW or greater of solar electric	1	1
	Reduce fenestration from 14% to 10%	Not Applicable	-1

SF = Square Feet

- 1 Cool roof with three-year aged solar reflectance of 0.55 and 3-year aged thermal emittance of 0.75 or 3-year aged solar reflectance index of 64.
- 2 One cfm/ft<sup>2</sup> attic venting.
- 3 Radiant barrier shall have an emissivity of no greater than 0.05 as tested in accordance with ASTM E-408. The radiant barrier shall be installed in accordance with the manufacturer's installation instructions.
- 4 Walls with covering with a reflectance of  $\geq$  0.64.

- 5 Energy Star rated appliances include refrigerators, dishwashers, and clothes washers and must be installed for the final inspection.
- 6 The wall projection factor is equal to the horizontal distance from the surface of the wall to the farthest most point of the overhang divided by the vertical distance from the first floor level to the bottom most point of the overhang.
- 7 All air conditioning systems in the house must be ductless to qualify for this credit.
- 8 Install ceiling fans in all bedrooms and the largest habitable space that is not used as a bedroom.”

(46) Subsection R501.4 of the International Energy Conservation Code is amended to read as follows:

**“R501.4 Compliance.** *Alterations, repairs, additions* and changes of occupancy to, or relocation of, existing buildings and structures shall comply with the provisions and regulations for *alterations, repairs, additions* and changes of occupancy or relocation, as adopted by the code official.”

(47) Subsection R502.1 of the International Energy Conservation Code is amended to read as follows:

**“R502.1 General.** Additions to an existing building, building system or portion thereof shall conform to the provisions of this code as those provisions relate to new construction without requiring the unaltered portion of the existing building or building system to comply with this code. Additions shall not create an unsafe or hazardous condition or overload existing building systems. An addition shall be deemed to comply with this code where the addition alone complies, where the existing building and addition comply with this code as a single building, or where the building with the addition uses no more energy than the existing building. Additions shall be in accordance with Section R502.1.1 or R502.1.2.

**Exceptions:**

1. When addition includes unconditioned space that does not contain habitable space.
2. When both the existing building and addition are entirely comprised of habitable unconditioned space if total square footage does not increase more than 1,100 square feet.”

- (48) Subsection R503.1.1 of the International Energy Conservation Code is amended to read as follows:

**R.503.1.1 Building envelope.** Building envelope assemblies that are part of the alteration shall comply with Section R402.1.2 or R402.1.4, Sections R402.2.1 through R402.2.13, R402.3.1, R402.3.2, R402.4.3 and R402.4.4.

**Exception:**

The following alterations need not comply with the requirements for new construction provided the energy use of the building is not increased:

1. Storm windows installed over existing fenestration.
2. Existing ceiling, wall or floor cavities exposed during construction provided that these cavities are filled with insulation.
3. Construction where the existing roof, wall or floor cavity is not exposed.
4. Roof recover.
5. Roof replacement of uninsulated roofs which include at least one of the following:
  - a. Energy Star compliant roof covering;
  - b. Radiant barrier; or
  - c. Attic ventilation via solar attic fans or ridge ventilation or gable ventilation.
6. Surface-applied window film installed on existing single pane fenestration assemblies to reduce solar heat gain provided the code does not require the glazing or fenestration assembly to be replaced.”

- (49) Subsection R503.2 of the International Energy Conservation Code is amended to read as follows:

**R503.2 Change in space conditioning.**

Any nonconditioned or low-energy space that is altered to become *conditioned space* shall be required to be brought into full compliance with this code.

**Exceptions:**

1. Where the simulated performance option in Section R405 is used to comply with this section, the annual energy cost of the proposed design is permitted to be 110 percent of the annual energy cost otherwise allowed by Section R405.3.
2. When specified in the tropical zone, and the total conditioned space does not exceed 50% of the habitable floor area, and, R-19 is installed over the conditioned space, and Split ductless air conditioner systems with a SEER rating in the top 25% of readily available units are installed.”

**SECTION 6.** The Hawai'i County Code 1983 (2016 Edition, as amended) is amended by adding a new chapter, relating to the plumbing code, to be designated chapter 5F, and to read as follows:

**“CHAPTER 5F. PLUMBING CODE.**

**Article 1. General Provisions.**

**Section 5F-1-1. Title.**

This chapter shall be known as the “plumbing code.”

**Section 5F-1-2. Purpose.**

The purpose of this chapter is to provide for the protection of the public health and safety by establishing minimum standards for the installation, alteration, or repair of plumbing, gas, and drainage systems and the inspection thereof in the County.

**Section 5F-1-3. Scope; exceptions.**

This chapter shall apply to all new construction, relocated buildings, and to any alterations, repairs, or reconstruction within the property lines of the premises, within the County inland of the shoreline high-water line. Exceptions to these minimum requirements are listed below:

This chapter shall not apply to:

- (1) Work or installations not covered by the Uniform Plumbing Code, 2012 Edition, as adopted by the Hawai'i State Plumbing Code;
- (2) Work on buildings or premises owned by or under the direct control of the Federal government;
- (3) Work in public State or County road right-of-ways for utility installations and mechanical equipment not specifically regulated in this code where installed:
  - (A) Outside the proposed premises or boundary lines in a subdivision under development; or
  - (B) In an approved subdivision, where the work is in planned or actual roadways or other common infrastructure areas;
- (4) Pursuant to section 448E-13, Hawai'i Revised Statutes, work by employees of a public utility within the State under a franchise or charter granted by the State which is regulated by the public utilities commission and community antennae television company, while so employed;
- (5) Plumbing work related to work regulated by chapter 397, Hawai'i Revised Statutes, relating to boilers and pressure vessels; or
- (6) Agricultural buildings, structures, and appurtenances without electrical power and plumbing systems are exempt from permit and construction code requirements, pursuant to section 46-88, Hawai'i Revised Statutes, except as otherwise provided for in this construction code. No plumbing systems shall be connected to a building or structure without first obtaining a permit for plumbing work.

**Section 5F-1-4. Administrative provisions.**

Provisions relating to permitting, enforcement, inspection, and other administrative procedures pertaining to this chapter are contained in chapter 5, the construction administrative code.

**Section 5F-1-5. Existing plumbing installations.**

Plumbing installations in existence and permitted pursuant to applicable laws and standards in effect when the plumbing work thereon was performed, shall not be deemed to be in violation of subsequent changes to applicable laws or standards, provided that such installations shall be subject to the provisions of section 5-2-3 of the construction administrative code.

**Section 5F-1-6. Definitions.**

As used in this chapter, unless it is apparent from the context that a different meaning is intended:

**“Accessory structure”** means a structure not greater than 3,000 square feet (279 m<sup>2</sup>) in floor area, and not over two stories in height, the use of which is customarily accessory to and incidental to that of the dwelling and which is located on the same lot.

**“Authority having jurisdiction”** means the director of the department of public works, or the director’s authorized representative.

**“Building”** means any structure used or intended for supporting or sheltering any use or occupancy. The term shall include but not be limited to, any structure mounted on wheels such as a trailer, wagon, or vehicle which is parked and stationary for any 24-hour period, and is used for business or living purposes; provided, however, that the term shall not include a push cart or push wagon which is readily movable and which does not exceed 25 square feet in area, nor shall the term include a trailer or vehicle, used exclusively for the purpose of selling any commercial product therefrom, which hold a vehicle license and actually travels on public or private streets.

**“Certified medical gas installer”** means a qualified installer who has successfully passed a National Inspection Testing Certification Service competency examination in accordance with the ASSE Series 6000 Standard, section 6010.

**“Certified medical gas verifier”** means a qualified installer who has successfully passed a National Inspection Testing Certification Service competency examination in accordance with the ASSE Series 6000 Standard, Section 6030.

**“This code”** means the plumbing code, contained in chapter 5F, or the construction administrative code, contained in chapter 5, or both, as the context requires.

**“Construction code”** means collectively: chapter 5, the construction administrative code; chapter 5A, the building code; chapter 5D, the electrical code; chapter 5E, the energy conservation code; chapter 5F, the plumbing code; and all administrative rules adopted pursuant to these chapters.

**“Director”** means the director of public works of the County of Hawai‘i or the director’s duly authorized representative.

**“Dwelling”** means any building that contains one or two dwelling units used, intended, or designed to be built, used, rented, leased, let or hired out to be occupied, or that are occupied for living purposes.

**“Dwelling unit”** means a single unit providing complete independent living facilities for one or more persons, including permanent provisions for living, sleeping, eating, cooking, and sanitation.

**“Engineer”** means a person who is licensed and in good standing as a professional engineer in the State of Hawai‘i.

**“Existing building”** means a building erected prior to the effective date of this chapter, or one for which a legal permit has been issued.

**“Existing structure”** means a structure erected prior to the effective date of this chapter, or one for which a legal permit has been issued.

**“IAPMO”** means the International Association of Plumbing and Mechanical Officials.

**“Permit”** means a formal authorization issued by the authority having jurisdiction that authorizes performance of specified work, pursuant to the following chapters:

- (1) 5, the construction administrative code;
- (2) 5A, the building code;
- (3) 5D, the electrical code;
- (4) 5E, the energy conservation code; and
- (5) 5F, the plumbing code.

**“Person”** means any individual, firm, partnership, association, or corporation, or its or their successors or assigns, according to the context thereof.

**“Plumbing work”** means the design, installation, alteration, construction, reconstruction, or repair of plumbing, gas, and drainage systems.

**“Section”** means a section of a chapter of the Uniform Plumbing Code.

**“UPC”** means the Uniform Plumbing Code as published by the International Association of Plumbing and Mechanical Officials.

**Section 5F-1-7. Compliance required.**

- (a) No person shall perform or cause to be performed any plumbing work which does not comply with the provisions of this code or any permit issued pursuant to this code.

- (b) No person shall perform any work covered by this code in violation of the provisions of chapter 448E, Hawai‘i Revised Statutes.
- (c) Any approval or permit issued pursuant to the provisions of this code shall comply with all applicable requirements of this code.
- (d) The granting of a permit, variance, or approval of plans or specifications pursuant to this code does not dispense with the necessity to comply with any applicable law to which a permit holder may also be subject.

**Section 5F-1-8. Conflict.**

- (a) If any provisions of this code conflict with or contravene provisions of the Hawai‘i State Plumbing Code or the Uniform Plumbing Code that have been incorporated by reference, the provisions of this code shall prevail as to all matters and questions arising out of the subject matter of such provisions.
- (b) In situations where two or more provisions of this code and any applicable law, other than those provided for in subsection (a), cover the same subject matter, the stricter shall be complied with.

**Article 2. Installation Requirements.**

**Section 5F-2-1. Uniform plumbing code adopted.**

The Uniform Plumbing Code, 2012 Edition, published by the International Association of Plumbing and Mechanical Officials, 5001 E. Philadelphia Street, Ontario, CA 91761-2816, including appendices, is incorporated by reference and made a part of this code, subject to any amendments hereinafter set forth in this chapter.

- (a) The scope, technical specifications, and exemptions set forth in the Uniform Plumbing Code, 2012 Edition, are hereby adopted as the standard for plumbing work covered by this code, provided there are no specific provisions in any other section of this code covering the particular matter.
- (b) A copy of the Uniform Plumbing Code, 2012 Edition, shall be available for public inspection at the Hilo and Kailua-Kona offices of the department of public works and at the office of the County clerk.
- (c) This incorporation by reference includes all parts of the Uniform Plumbing Code, 2012 Edition, subject to the amendments hereinafter set forth.
  - (1) Section 204.0 of the Uniform Plumbing Code is amended by amending the definition of “Building Drain” to read as follows:

**“Building Drain.** That part of the lowest piping of a drainage system that receives the discharge from soil, waste, and other drainage pipes inside the walls of buildings and

conveys it to the building sewer beginning [~~2 feet (610 mm)~~] five (5) feet (1524 mm) outside the building wall.”

- (2) Section 210.0 of the Uniform Plumbing Code is amended by adding a new definition of “Health Officer” to read as follows:

“**Health Officer.** Health Officer shall mean the director of health of the department of health, State of Hawai‘i, or the director’s authorized agent.”

- (3) Section 221.0 of the Uniform Plumbing Code is amended by adding a new definition of “Single Stack Vent System” to read as follows:

“**Single Stack Vent System.** A specially designed plumbing system wherein a common stack serves as a drainage pipe as well as a vent pipe.”

- (4) A new subsection 313.8 is added to the Uniform Plumbing Code to read as follows:

“**313.8 Seismic Supports.** Where earthquake load are applicable in accordance with the building code, plumbing piping supports shall be designed and installed for the seismic forces in accordance with the building code.”

- (5) Subsection 402.5 of the Uniform Plumbing Code is amended to read as follows:

“402.5 Setting. Fixtures shall be set level and in proper alignment with reference to adjacent walls. No water closet or bidet shall be set closer than 15 inches (381 mm) from its center to a side wall or obstruction nor closer than 30 inches (762 mm) center to center to a similar fixture. The clear space in front of [a] any water closet [or], bidet, and lavatory, shall not be [set closer] less than [12 inches (305 mm) from its center to a side wall or partition nor closer than] 24 inches (610mm) which may include adjoining floor area [center to center].”

- (6) Section 422.0 and Table 422.1 of the Uniform Plumbing Code are repealed in their entirety.

- (7) The Uniform Plumbing Code is amended by adding a new section 422.0 to read as follows:

“**422.0 Minimum Number of Required Fixtures.** Plumbing fixtures shall be provided for the type of building occupancy and in the minimum number required in Chapter 29 of the International Building Code.”

- (8) Subsection 507.13 of the Uniform Plumbing Code is amended by adding the following Exception to the end thereof, to read as follows:

“**EXCEPTION:**

- (1) Water heaters may be installed at floor level in carports having one

hundred (100) percent opening on one side and fifty (50) percent net opening on another side or the equivalent of such openings on two or more sides, provided the adjacent ground level is at or below the flow level of the carport.

(2) Fuel burning water heaters having sealed combustion chambers may be installed at floor level.

(3) Electric water heaters in garages may be installed at floor level.”

(9) A new subsection 508.4.5 is added to the Uniform Plumbing Code to read as follows:

“**508.4.5 Access.** Every attic, mezzanine, or platform more than 16 feet (4.9 meters) above the ground floor level shall be accessible by a stairway or ladder permanently fastened to the building.

Exception: No permanent access required for R-3 Occupancies.”

(10) Subsection 604.11 of the Uniform Plumbing Code is amended to read as follows:

“**Lead Content.** ~~[Water pipe and fittings with a lead content which exceeds 8 percent shall be prohibited in piping systems used to convey potable water.]~~ The maximum allowable lead content in pipes, pipe fittings, plumbing fittings, and fixtures intended to convey or dispense water for human consumption shall be not more than a weighted average of 0.25 percent with respect to the wetted surfaces of pipes, pipe fittings, plumbing fittings, and fixtures. For solder and flux, the lead content shall be not more than 0.2 percent where used in piping systems that convey or dispense water for human consumption.

Exceptions:

(1) Pipes, pipe fittings, plumbing fittings, fixtures or backflow preventers used for nonpotable services such as manufacturing, industrial processing, irrigation, outdoor watering, or any other uses where the water is not used for human consumption.

(2) Water closets, bidets, urinals, fill valves, flushometer valves, tub fillers, shower valves, service saddles, or water distribution main gate valves that are 2 inches (50 mm) in diameter or larger.”

(11) Subsection 608.3 of the Uniform Plumbing Code is amended by adding a third sentence to the first paragraph to read as follows:

“Cylinder Expansion Tanks more than twenty-four (24) inches in vertical height, shall be secured against seismic movements within the upper top one third (1/3) of its vertical dimensions.”

- (12) Subsection 608.5 of the Uniform Plumbing Code is amended to read as follows:

**“608.5 Drains.** Relief valves [~~located inside a building~~] shall be provided with a drain, not smaller than the relief valve outlet, of galvanized steel, hard-drawn copper piping and fittings, CPVC, PP, or listed relief valve drain tube with fittings that will not reduce the internal bore of the pipe or tubing (straight lengths as opposed to coils) and shall extend from the valve to the outside of the building, with the end of the pipe not more than 2 feet (610 mm) nor less than 6 inches (152 mm) aboveground or the flood level of the area receiving the discharge and pointing downward. Such drains shall be permitted to terminate at other approved locations. Relief valve drains shall not terminate in a building’s crawl space. No part of such drain pipe shall be trapped or subject to freezing. The terminal end of the drain pipe shall not be threaded.”

- (13) Subsection 715.1 of the Uniform Plumbing Code is amended to read as follows:

**“715.1 Materials.** The building sewer, beginning [~~2 feet (610 mm)~~] 5 feet (1524 mm) from [~~any~~] a building or structure shall be of such materials as prescribed in this code.”

- (14) A new subsection 911.3 is added to the Uniform Plumbing Code to read as follows:

**“911.3 Single Stack System.** When approved by the administrative authority, a single-stack system based on engineered studies and tests may be used in lieu of other related provisions in this code. Plans and specifications of such systems shall be prepared and stamped by a Hawaii licensed mechanical engineer.”

- (15) Subsection 1101.11.1 of the Uniform Plumbing Code is amended to read as follows:

**“1101.11.1 Primary Roof Drainage.** Roof areas of a building shall be drained by roof drains or gutters. The location and sizing of drains and gutters shall be coordinated with the structural design and pitch of the roof. Unless otherwise required by the Authority Having Jurisdiction, roof drains, gutters, vertical conductors or leaders, and horizontal storm drains for primary drainage shall be sized based on a storm of 60 minutes duration and 100 year return period. Refer to [~~Table D-1.1 (in Appendix D)~~] the National Weather Service rainfall map for 100 year, 60 minute storms at various locations.”

- (16) Subsection 1211.5 of the Uniform Plumbing Code is amended by adding a third sentence to read as follows:

“Ground-joint unions may only be used at exposed fixture, appliance, or equipment connections and in exposed exterior locations immediately on the discharge side of a building shutoff valve. Heavy duty flanged type unions may be used in special cases, when first approved by the administrative authority. Bushings shall not be used in concealed locations.”

- (17) A new subsection 1212.2 is added to the Uniform Plumbing Code to read as follows:

**“Anchored or strapped. Liquefied Petroleum Gas Cylinder Tank Facilities more than 24 inches in vertical height, shall be secured against seismic movements within upper top-third (1/3) of its vertical dimensions.”**

- (18) A new subsection 1301.4 is added to the Uniform Plumbing Code to read as follows:

“The provisions of ‘Part 1 - Special Requirements for Health Care Facilities’ shall be for REFERENCE ONLY, FOR DESIGN AND CONSTRUCTION. This section will not be regulated or enforced by the County of Hawai‘i.”

- (19) Subsection 1309.1 of the Uniform Plumbing Code is amended to read as follows:

**“General.** The provisions [~~herein shall apply to the installation, testing, and verification of medical gas and vacuum piping in hospitals, clinics, and other health care facilities~~] of ‘Part II - Medical Gas and Vacuum Systems’ shall be for REFERENCE ONLY, FOR DESIGN AND CONSTRUCTION. This section will not be regulated or enforced by the County of Hawai‘i. Installation of medical gas and vacuum piping shall be conducted by qualified Medical Gas Installers meeting the requirements of ASSE 6010. Testing and verification shall be conducted by ‘Certified Medical Gas System Verifier’ in accordance with ASSE 6030.”

- (20) Section 1326.0 of the Uniform Plumbing Code is amended by replacing “Authority Having Jurisdiction” with “Certified Medical Gas Verifier” throughout subsections 1326.1 through 1326.15.

- (21) Subsection 1327.3 of the Uniform Plumbing Code is amended to read as follows:

**“1327.3 Reports.** The inspection and testing reports shall be submitted directly to the party that contracted for the testing, who shall submit the report through channels to the responsible facility authority and others that are required.

Reports shall contain detailed listings of findings and results. [~~NFPA 99:5.1.12.1.6, 5.1.12.1.7~~]

**The licensed mechanical engineer responsible for the design and observation of the system shall provide a statement that the certification tests of section 1326.0 as applicable, have been verified and to the best of such engineer's knowledge complies with the installation requirements.”**

- (22) Table 1401.1 of the Uniform Plumbing Code is amended by adding the following standards to be inserted between Standard Number SAE-J1670-2008 and TCNA A118-10-2011:

Standard Number	Standard Title	Application	Referenced Sections
State of Hawai'i - Rev. Sept. 2000	Standard Details for Public Works Construction	Various	Various
State of Hawai'i - 2002	Water System Standards	Various	Various

- (23) Subsection 1601.3 of the Uniform Plumbing Code is amended to read as follows:

**“1601.3 Permit or Approval.**

It shall be unlawful for [a] any person to construct, install, alter, or cause to be constructed, installed, or altered [an] any alternate water source system in a building or on a [~~premise~~] premises without first obtaining a permit or approval to do such work from the Authority Having Jurisdiction.

**Exceptions:**

- (1) A permit is not required for exterior rainwater catchment systems used for outdoor drip and subsurface irrigation with a maximum storage capacity of 360 gallons (1363 L).
- (2) A plumbing permit is not required for rainwater catchment systems for single family dwellings where outlets, piping, and system components are located on the exterior of the building. This does not exempt the need for permits where required for electrical connections, tank supports, or enclosures.”

- (24) Subsection 1602.7 of the Uniform Plumbing Code amended by amending the first paragraph to read as follows:

**“1602.7 Drawings and Specifications.** The Authority Having Jurisdiction shall require the following information to be included with or in the plot plan before a permit or approval is issued for a gray water system, or at a time during the construction thereof:”

- (25) Appendix D of the Uniform Plumbing Code, “Sizing Storm Water Drainage Systems,” is deleted in its entirety.
- (26) Appendix E of the Uniform Plumbing Code, “Manufactured/Mobile Home Parks and Recreational Vehicle Parks,” is deleted in its entirety.
- (27) Appendix F of the Uniform Plumbing Code, “Firefighter Breathing Air Replenishment Systems,” is deleted in its entirety.

- (28) Appendix G of the Uniform Plumbing Code is amended by amending its title to read as follows:

**“APPENDIX G  
SIZING OF VENTING SYSTEMS SERVING APPLIANCES EQUIPPED WITH  
DRAFT HOODS, CATEGORY I APPLIANCES, AND APPLIANCES LISTED  
FOR USE WITH TYPE B VENTS**

**FOR REFERENCE ONLY**

(The content of this Appendix is based on Annex G of NFPA 54)”

- (29) Appendix H of the Uniform Plumbing Code, “Private Sewage Disposal Systems,” is amended by amending its title to read as follows:

**“APPENDIX H  
COMMERCIAL OR INDUSTRIAL SPECIAL LIQUID WASTE DISPOSAL**

**FOR REFERENCE ONLY”**

**Article 3. Plumbing Work Within Special Flood Hazard Areas.**

**Section 5F-3-1. General applicability.**

- (a) The provisions of this article shall apply to the: installation of any new plumbing system; or the renovation and major alteration, addition, or reinstallation of any existing plumbing system within a special flood hazard area as identified by chapter 27, Hawai‘i County Code. All installations shall comply with chapter 27, Floodplain Management.
- (b) The provisions of this article shall not apply to the following:
- (1) Any plumbing system serving a building or structure exempted from chapter 27;
  - (2) Any plumbing system serving a building or structure which has been granted a flood control variance pursuant to article 2, chapter 27; or
  - (3) Any plumbing system lawfully existing prior to November 8, 1993, subject to the provisions of chapter 27.

**Section 5F-3-2. Definitions.**

As used in this article, unless it is apparent from the context that a different meaning is intended:

**“Base flood elevation”** means the water surface elevation of the base flood.

**“Flood or flooding”** means:

- (1) A general and temporary condition of partial or complete inundation of normally dry land areas from:
  - (A) The overflow of inland or tidal waters;

- (B) The unusual and rapid accumulation or runoff of surface waters from any source; or
  - (C) Mudslides (i.e., mudflows) which are approximately caused by flooding as defined in paragraph (1)(B) of this definition and are akin to a river of liquid and flowing mud on the surfaces of normally dry land areas, as when earth is carried by a current of water and deposited along the path of the current; or
- (2) The collapse or subsidence of land along the shore of a lake or other body of water as a result of erosion or undermining caused by waves or currents of water exceeding anticipated cyclical levels or suddenly caused by an unusually high water level in a natural body of water, accompanied by a severe storm, or by an unanticipated force of nature, such as flash flood or an abnormal tidal surge, or by some similarly unusual and unforeseeable event which results in flooding as defined in paragraph (1)(A) of this definition.

**“Special flood hazard area”** means an area having special flood or flood-related erosion hazards, and shown on the Flood Insurance Rate Maps as Zones A, AO, AE, A99, AH, VE, or V.”

**Section 5F-3-3. Drainage (plumbing) systems.**

- (a) Drainage systems that have openings below the base flood elevation shall be provided with an automatic backwater valve installed in each discharge line passing through a building exterior wall, except backwater valves may be deleted if the fixture drainage openings are located at or above a floor level which is above the surrounding ground level.
- (b) Drainage systems for emergency servicing facilities that are required to remain in operation during a flood shall be provided with a sealed holding tank and the necessary isolation and diversion piping and appurtenances to withhold or postpone sewage discharge to the sewer system during the flood. The holding tank shall be sized for storage of at least one hundred fifty percent of the anticipated demand for a twenty-four hour period. Vents provided for such holding tank shall terminate at an elevation of at least one foot above the base flood elevation.
- (c) All pipes in a plumbing vent system shall terminate at an elevation of at least one foot above the base flood elevation.
- (d) All pipe openings through exterior walls below the base flood elevation shall be floodproofed to prevent infiltration of flood water through spaces between pipes and wall construction materials by use of embedded collars, sleeves, waterstops, or other means as may be approved by the authority having jurisdiction.

**Section 5F-3-4. Private sewage disposal/treatment.**

An individual private sewage disposal system or a treatment facility may be permitted in a special flood hazard area when the design and location of such system or facility is approved by the State department of health. In addition to complying with public health regulations and administrative rules of the State department of health, any such new or replacement sewage disposal system shall be designed to minimize or eliminate infiltration of flood waters into the system and discharges from the system into flood waters.

**Section 5F-3-5. Water supply systems.**

- (a) Potable water supply systems that are located in a special flood hazard area shall be designed and installed in such a manner as to prevent contamination from flood waters up to the base flood elevation. Location and construction of private water supply wells shall comply with rules and regulations of the department of water supply of the County of Hawai'i.
- (b) Potable water supply tanks, filters, softeners, heaters, and all water-supplied appliances and fixtures located below the base flood elevation shall be protected against contamination by covers, walls, copings, or castings. All vent pipes serving the water supply system shall terminate at an elevation of at least one foot above the base flood elevation.
- (c) Backflow preventers or devices approved by the department of water supply shall be installed on water service lines as close to the property control valve as possible to protect the public water system from backflow or back siphonage of flood waters or other contaminants in the event of a line break. Devices shall be installed at accessible locations and shall be maintained in good working condition by the owner. The backflow preventers or devices shall be subject to periodic testing as prescribed in the rules and regulations of the department of water supply.
- (d) An approved double-check valve assembly shall be used in lieu of any vacuum breaker, permitted, or otherwise required under this chapter when located below the regulatory flood elevation.
- (e) Air relief valves are permitted on private pipelines only when installed at least one foot above the base flood elevation.

**Section 5F-3-6. Plumbing piping under buildings.**

Plumbing piping under buildings constructed on stilts shall be securely anchored against lateral movement and flotation and protected against damage by flood water and debris. Protection shall be provided by the structural enclosure of such piping or by attaching such piping to the downstream side of structural members which are large enough to provide this protection.

## PART II. AMENDMENTS TO OTHER ORDINANCES

**SECTION 7.** Chapter 2, article 9, section 2-39, of the Hawai‘i County Code 1983 (2016 Edition, as amended) is amended to read as follows:

**“Section 2-39. Duties of director of public works.**

The director of public works shall be charged with the supervision, direction, and control of:

- (1) The construction, repair, maintenance, and operation of all County buildings, structures, and grounds, not otherwise delegated to any other department of the County;
- (2) The administration and enforcement of the [~~building code, electrical code, housing code, plumbing code, and~~] County construction code that includes collectively: the construction administrative code; the building code; the electrical code; the energy conservation code; and the plumbing code, as well as all ordinances and statutes related to the responsibilities assigned to the department of public works; and
- (3) The administration, control, and operation of all divisions and bureaus of the department of public works and the appointment, transfer, promotion, demotion, or dismissal of all necessary personnel.”

**SECTION 8.** Chapter 3, article 1, sections 3-14 and 3-15, of the Hawai‘i County Code 1983 (2016 Edition, as amended) are amended to read as follows:

**“Section 3-14. [~~Building~~] Construction code permits.**

Persons applying for a [~~building~~] permit pursuant to the County construction code, including chapters 5 and 5A through 5F, are encouraged to include a sign plan for any signs that will be erected in conjunction with the new construction or improvements for which the [~~building~~] permit is requested in order that the department and applicant may assess the applicability of any additional permit requirements under this chapter.

**Section 3-15. Illuminated signs.**

A permit application for a sign which uses electrical wiring and connections or which is illuminated by an external source, shall be submitted to the electrical inspector who shall examine the plans and specifications of all wiring and connections of the sign itself to determine if they comply with chapter [9]5D, Hawai‘i County Code, relating to [~~electricity~~] the electrical code and chapter 14, article 9, Hawai‘i County Code, relating to outdoor lighting. The electrical inspector shall recommend (1) approval of the application if the plans and specifications comply with chapter [9]5D and chapter 14, article 9, or (2) disapproval of the application if noncompliance with these chapters is found. The plans and specifications shall then be returned to the director for final action in compliance with section 3-18.”

**SECTION 9.** Chapter 25, article 1, section 25-1-5, of the Hawai‘i County Code 1983 (2016 Edition, as amended) is amended by amending subsection (a) to read as follows:

“(a) Building construction and development terms that are not defined in this chapter shall be given their respective definitions as found in the ~~[building code (chapter 5)]~~ County construction code, including chapters 5 and 5A through 5F.”

**SECTION 10.** Chapter 25, article 4, section 25-4-10, of the Hawai‘i County Code 1983 (2016 Edition, as amended) is amended to read as follows:

**“Section 25-4-10. Mobile dwellings.**

All mobile dwellings shall conform to the County ~~[building code (chapter 5 of this Code)]~~ construction code, including chapters 5 and 5A through 5F, and the Public Health Housing Code (chapter 2 of the State public health regulations), except:

- (1) When parked in a licensed mobile home park; or
- (2) When occupied for dwelling or sleeping purposes outside of a licensed mobile home park for less than thirty days in any one location.”

**SECTION 11.** Chapter 25, article 4, section 25-4-60, of the Hawai‘i County Code 1983 (2016 Edition, as amended) is amended by amending subsection (b) to read as follows:

“(b) If the portion of the building that is nonconforming should be destroyed it may only be rebuilt in compliance with all of the requirements ~~[under the County building code]~~ of the County construction code, including chapters 5 and 5A through 5F for reconstruction and repair of nonconforming buildings.”

### PART III. REPEALED CHAPTERS

**SECTION 12.** Chapters 5, 9, and 17 of the Hawai‘i County Code 1983 (2016 Edition, as amended), are repealed.

PART IV.

**SECTION 13.** Material to be repealed is bracketed and stricken. New material is underscored. In printing this ordinance, the brackets, bracketed and stricken material, and underscoring need not be included.

**SECTION 14.** When amendments to the International Building Code, 2006 Edition, the National Electrical Code, 2017 Edition, the International Energy Conservation Code, 2015 Edition, and the Uniform Plumbing Code, 2012 Edition, as set forth in this ordinance, are indicated through the use of Ramseyer formatting, with material to be repealed bracketed and stricken and new material underscored, the brackets, bracketed and stricken material, and underscoring need not be included when this ordinance is printed.

**SECTION 15.** Work performed pursuant to a permit issued before the effective date of this ordinance and which is inspected on or after such effective date shall be approved if it meets the requirements of the code in effect at the time the permit was issued.

**SECTION 16.** Applications for permits submitted before the effective date of this ordinance pursuant to chapters 5, 9, and 17 that are deemed complete by the director of the department of public works, shall be approved if such applications meet the requirements of either this ordinance or the provisions of chapters 5, 9, and 17.

**SECTION 17.** Severability. If any provision of this ordinance, or the application thereof to any person or circumstance, is held invalid, the invalidity does not affect other provisions or applications of the ordinance which can be given effect without the invalid provision or application, and to this end the provisions of this ordinance are severable.

**SECTION 18.** This ordinance shall take effect upon its approval, but nothing in this ordinance shall be construed to prohibit any person from complying with the provisions of this article and any amendments thereto adopted prior to the enactment of this ordinance.

INTRODUCED BY:

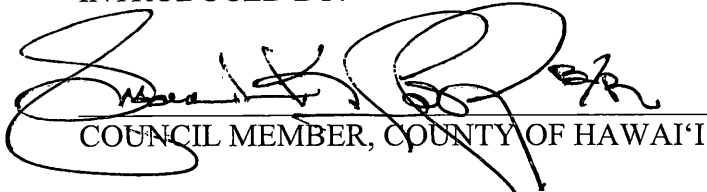
  
COUNCIL MEMBER, COUNTY OF HAWAI'I

\_\_\_\_\_, Hawai'i  
Date of Introduction:  
Date of 1st Reading:  
Date of 2nd Reading:  
Effective Date:

REFERENCE Comm. 989.37